

PP-100AP

User's Guide

M00019500

Disc producer™

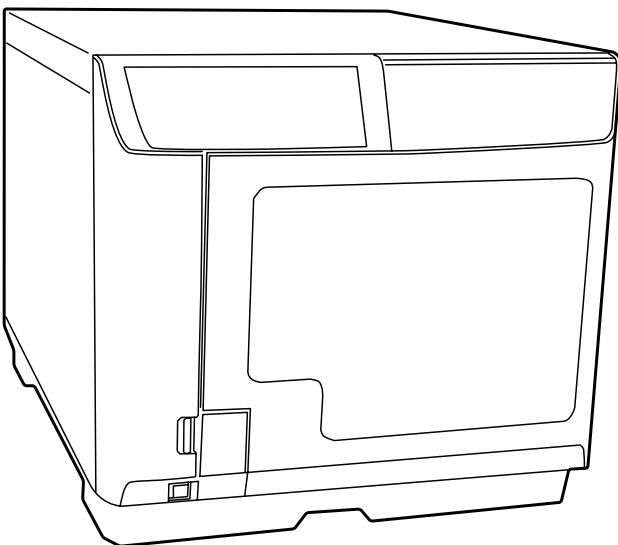

Copyright and Trademarks

All rights reserved. No part of this publication may be reproduced, stored in a retrieval system, or transmitted in any form or by any means, electronic, mechanical, photocopying, recording, or otherwise, without the prior written permission of Seiko Epson Corporation. No patent liability is assumed with respect to the use of the information contained herein. While every precaution has been taken in the preparation of this book, Seiko Epson Corporation assumes no responsibility for errors or omissions. Neither is any liability assumed for damages resulting from the use of the information contained herein.

Neither Seiko Epson Corporation nor its affiliates shall be liable to the purchaser of this product or third parties for damages, losses, costs, or expenses incurred by purchaser or third parties as a result of: accident, misuse, or abuse of this product or unauthorized modifications, repairs, or alterations to this product, or (excluding the U.S.) failure to strictly comply with Seiko Epson Corporation's operating and maintenance instructions.

Seiko Epson Corporation shall not be liable against any damages or problems arising from the use of any options or any consumable products other than those designated as Original Epson Products or Epson Approved Products by Seiko Epson Corporation.

EPSON is a registered trademark of Seiko Epson Corporation in Japan and other countries/regions.

Microsoft, Windows, Windows Vista, and Windows 7 are registered trademarks or a trademark of Microsoft Corporation in the United States and/or other countries.

General Notice: Other product names used herein are for identification purposes only and may be trademarks of their respective owners. Epson disclaims any and all rights in those marks.

NOTICE: The contents of this manual are subject to change without notice.

Copyright © 2009 Seiko Epson Corporation. All rights reserved.

Contents

Copyright and Trademarks

Important Notice and Safety Instructions

Important Note	7
Important Safety Instructions	7
Setting up the product	7
Choosing a place for the product	8
Using the product	9
Handling ink cartridges	9
Notice for CD/DVD discs	10
Concerning incidental loss arising out of this product	11
About usage limitation	11
Warnings, Cautions, and Notes	12

Chapter 1 Using Your Software

System Requirements	13
For using the product	13
Adding the product	14
Setting Working Folder	15
Overview of Applications	16
EPSON Total Disc Maker	16
EPSON Total Disc Monitor	16
EPSON Total Disc Setup	16
Using EPSON Total Disc Maker	16
Starting EPSON Total Disc Maker	16
Getting information through online help	17
Overview of Printer Driver	17
Accessing the printer driver	17
Getting information through online help	18
Uninstalling Software	19

Chapter 2 Publishing Discs

Introduction	20
Turning power on/off	20
Overview of publishing mode	21

Drive settings	22
Printer settings	22
Notice for CD/DVD writing and printing	23
Precautions for Duplicating CDs/DVDs	25
Printing on CDs/DVDs with a commercially available software package	26
Notice for barcode printing	26
Standard Mode	27
Loading CDs/DVDs	27
Making disc settings and creating labels	29
Registering data	30
Creating labels	32
Making the stacker settings	35
Publishing Discs	37
External Output Mode	39
Loading CDs/DVDs	39
Making disc settings and creating labels	42
Registering data	43
Creating labels	45
Making the stacker settings	48
Publishing Discs	51
Batch Mode	54
Loading CDs/DVDs	54
Making disc settings and creating labels	58
Registering data	59
Creating labels	61
Making the stacker settings	64
Publishing Discs	66
Taking Out Discs	68
Pausing Publishing	69
Resuming Publishing	70
Canceling Publishing	71

Chapter 3 Replacing Ink Cartridges

Checking the Ink Cartridge Status	72
Precautions on Ink Cartridge Replacement	73
Replacing an Ink Cartridge	74

Chapter 4 Maintaining Your Product

Checking the Print Head Nozzles	79
Using the Nozzle Check utility	79
Cleaning the Print Head	80

Using the Head Cleaning utility	81
Using the product buttons	82
Aligning the Print Head	82
Using the Print Head Alignment utility	82
Correcting the Printing Position	83
Using the Correcting the Printing Position utility	83
Cleaning Your Product.	84
Cleaning the exterior of the product.	84
Cleaning the interior of the product	85
Cleaning the filter.	85
Transporting Your Product.	86

Chapter 5 Troubleshooting

Diagnosing the Problem	88
Error indicators.	88
EPSON Total Disc Monitor	96
Checking Product Status	96
Using EPSON Total Disc Monitor	96
Disc or the CD/DVD Tray Does Not Feed Correctly	98
Disc does not feed	98
Multiple discs feed	99
Disc jams	99
Writing Problem	100
Cannot write to the disc	100
Print Quality Problems	100
Horizontal banding	101
Vertical misalignment.	102
Banding	102
Incorrect or missing colors	102
Blurry or smeared printout	103
Miscellaneous Printout Problems	103
Incorrect or garbled characters	103
Incorrect margins	104
Printout has a slight slant.	104
Printed side is smeared or scuffed.	104
Printing is too slow.	104
Ink adheres to the recording surface	105
The Product Does Not Function	105
All lights are off	105
Lights came on and then went out.	105
Only the power light is on.	106
The ink light is flashing or is on after you replace the cartridge.	106
Software cannot be installed	106

Ink Pad Nearly Full message is displayed by the software	107
Disc cannot be published.	107
Disc information cannot be read	107
DVD drive of the product is not displayed in Safely Remove Hardware	107

Appendix A Where To Get Help

Contacting Customer Support	108
Before Contacting Epson	108
Help for Users in the United States and Canada	108
Help for Users in the Europe (EMEA)	109

Appendix B Product Information

Product Parts and Control Panel Functions.	110
Product Parts	110
Control Panel	112
Ink and Disc.	113
Ink cartridges	113
Discs	113
Technical Specifications	114
Disc	114
Ink cartridges	118
Job processing	119
Printing	119
Write speed	120
Mechanical	120
Electrical	120
Environmental	121
Standards and approvals	121
Interface	121
Lifetime	121

Important Notice and Safety Instructions

Important Safety Instructions

Read all the instructions in this section before using the product. Also, be sure to follow all warnings and instructions marked on the product.

Setting up the product

Observe the following when setting up the product:

- Do not block or cover the vents and openings in the product.
- Use only the type of power source indicated on the product's label.
- Use only the power cord that comes with the product. Use of another cord may result in fire or electric shock.
- The product's power cord is for use with this product only. Use with other equipment may result in fire or electric shock.
- Be sure the AC power cord meets the relevant local safety standard.
- For safety reasons, make sure to ground the power cord.
- Avoid using outlets on the same circuit as photocopiers or air control systems that regularly switch on and off.
- Avoid electrical outlets controlled by wall switches or automatic timers.
- Keep the entire computer system away from potential sources of electromagnetic interference, such as loudspeakers or the base units of cordless telephones.
- Do not use a damaged or frayed power cord.
- If you use an extension cord with the product, make sure that the total ampere rating of the devices plugged into the extension cord does not exceed the cord's ampere rating. Also, make sure that the total ampere rating of all devices plugged into the wall outlet does not exceed the wall outlet's ampere rating.
- Do not attempt to service the product yourself.

- Unplug the product and refer servicing to qualified service personnel under the following conditions:
The power cord or plug is damaged; liquid has entered the product; the product has been dropped or the casing is damaged; the product does not operate normally or exhibits a distinct change in performance.
- If you plan to use the product in Germany, the building installation must be protected by a 10 or 16 amp circuit breaker to provide adequate short-circuit protection and over-current protection for the product.
- When connecting the product to a computer or other device with a cable, ensure the correct orientation of the connectors. Each connector has only one correct orientation. Inserting a connector in the wrong orientation may damage both devices connected by the cable.
- If damage occurs to the plug, replace the cord set or consult a qualified electrician. If there are fuses in the plug, make sure you replace them with fuses of the correct size and rating.

Choosing a place for the product

Observe the following when choosing a place for the product:

- Place the product on a flat, stable surface that extends beyond the base of the product in all directions. If you place the product by the wall, leave more than 10 cm (3.94") between the back of the product and the wall. The product will not operate properly if it is tilted at an angle.
- Leave enough space in front of the product for the disc cover to be fully opened.
- Avoid places subject to rapid changes in temperature and humidity. Also, keep the product away from direct sunlight, strong light, or heat sources.
- Avoid places subject to dust, shocks, vibrations, or cigarette smoke.
- Leave enough room around the product to allow for sufficient ventilation.
- Place the product near a wall outlet where the plug can be easily unplugged.

Using the product

Observe the following when using the product:

- Do not insert objects in the product.

- ❑ Take care not to spill liquid on the product.
- ❑ Do not use aerosol products that contain flammable gases inside or around this product. Doing so may cause fire.
- ❑ Always turn the product off using the ⏻ power button. When this button is pressed, the ○ ⏻ power light flashes. Do not unplug the product or turn off the power to the outlet until the ○ ⏻ power light stops flashing.
- ❑ Leave the ink cartridges installed. Removing the cartridges can dry out the print head and may prevent the product from printing.
- ❑ Be careful not to trap your fingers when closing the disc cover.
- ❑ The product uses galvanized sheet metal and this may cause rusting at the edges; however, this does not cause any harm to the function of the product.
- ❑ Do not place any drink or liquid on the product as penetration by liquid inside the product will cause a malfunction.
- ❑ When you have opened the disc cover while running a job (busy indicator is flashing), make sure that internal light has turned off and that the arm has stopped moving before performing any operation such as loading or taking out discs. Do not put your hands inside the product or operate stackers while the arm is moving. Also, open and close the disc cover gently.
- ❑ The product cannot be used as a shared printer using the Windows sharing setting.

Handling ink cartridges

Observe the following when handling the ink cartridges:

- ❑ Keep ink cartridges out of the reach of children. Do not allow children to drink from or handle the cartridges.
- ❑ Do not shake ink cartridges; this can cause leakage.
- ❑ Be careful when you handle used ink cartridges, as there may be some ink remaining around the ink supply port. If ink gets on your skin, wash the area thoroughly with soap and water. If ink gets into your eyes, flush them immediately with water. If discomfort or vision problems remain after a thorough flushing, see a doctor immediately.
- ❑ Do not remove or tear the label on the cartridge; this can cause leakage.
- ❑ Install the ink cartridge immediately after you remove it from its package. If you leave a cartridge unpacked for a long time before using it, normal printing may not be possible.

- ❑ Use the ink cartridge before the expiration date printed on its package.
- ❑ Do not dismantle ink cartridges or try to refill them. This could damage the print head.
- ❑ After bringing an ink cartridge inside from a cold storage site, allow it to warm up at room temperature for at least three hours before using it.
- ❑ Store ink cartridges in a cool, dark place.
- ❑ Do not touch the green IC chip on the side of the cartridge. Doing so may prevent normal operation and printing.
- ❑ The IC chip on this ink cartridge retains a variety of cartridge-related information such as the ink cartridge status, so that the cartridge may be removed and reinserted freely. However, each time the cartridge is inserted, some ink is consumed because the product automatically performs a reliability check.
- ❑ Do not place ink cartridges with the ink supply area facing down. This may result in ink leakage. Also, dirt attached to the ink supply area may result in the product not functioning properly.

Concerning incidental loss arising out of this product

Should the expected results from this product, including bundled software, not be obtained, we cannot compensate for incidental loss arising from that fact, such as expenses required for use of this product and lost earnings that would have been gained through the use of this product.

About usage limitation

- ❑ When this product is used for applications requiring high reliability/safety such as transportation devices related to aviation, rail, marine, automotive etc.; disaster prevention devices; various safety devices etc.; or functional/precision devices etc., you should use this product only after giving consideration to including fail-safes and redundancies into your design to maintain safety and total system reliability. Because this product was not intended for use in applications requiring extremely high reliability/safety such as aerospace equipment, main communication equipment, nuclear power control equipment, or medical equipment related to direct medical care etc., please make your own judgment on this product's suitability after a full evaluation.
- ❑ This product is for business use and not for household use.
- ❑ This product is for printing on labels of recording media such as CDs or DVDs and not for printing on paper.

Warnings, Cautions, and Notes

Warnings, Cautions, and Notes in this User's Guide as indicated below have the following meanings.



Warnings

must be followed carefully to avoid bodily injury.



Cautions

must be observed to avoid damage to your equipment.

Notes

contain important information and useful tips on the operation of the product.

WARNING

The connection of a non-shielded interface cable to this product will invalidate the EMC standards of this device. You are cautioned that changes or modifications not expressly approved by Seiko Epson Corporation could void your authority to operate the equipment.

FCC Compliance Statement For American Users

This equipment has been tested and found to comply with the limits for a Class B digital device, pursuant to Part 15 of the FCC Rules. These limits are designed to provide reasonable protection against harmful interference in a residential installation. This equipment generates, uses, and can radiate radio frequency energy and, if not installed and used in accordance with the instruction manual, may cause harmful interference to radio communications. However, there is no guarantee that interference will not occur in a particular installation. If this equipment does cause harmful interference to radio or television reception, which can be determined by turning the equipment off and on, the user is encouraged to try to correct the interference by one or more of the following measures:

- Reorient or relocate the receiving antenna.
- Increase the separation between the equipment and receiver.
- Connect the equipment into an outlet on a circuit different from that to which the receiver is connected.
- Consult the dealer or an experienced radio/TV technician for help.

For Canadian Users

This Class B digital apparatus complies with Canadian ICES-003.

Chapter 1

Using Your Software

Note:

To change the settings for PP-100AP using EPSON Total Disc Setup, please log on to Windows as a user with administrator privileges (belonging to the administrator group).

System Requirements

For using the product

Windows requirements

To use this product, you must have any of the following Windows operating systems installed.

Operating system	Windows 2000 Professional SP4 or later Windows XP (32bit, SP2 or later) Home Edition/Professional Windows Vista (32bit, SP1 or later) Home Basic/Home Premium/Business/Enterprise/Ultimate Windows 7 (32bit) Home Premium/Professional/Enterprise/Ultimate
CPU	Intel Pentium 4 (or compatible processor) 1.4 GHz or faster processor (2.4 GHz or faster recommended)
Memory	Windows 2000, Windows XP 512 MB or more (1 GB or more recommended) Windows Vista, Windows 7 1 GB or more
HDD	Windows 2000, Windows XP Available space: 10 GB or more Speed: 7200 rpm or faster Windows Vista Available space: 25 GB or more Speed: 7200 rpm or faster Windows 7 Available space: 26 GB or more Speed: 7200 rpm or faster

Interface	USB 2.0 <input type="checkbox"/> Compatible with USB 2.0 standard <input type="checkbox"/> Ensure Hi-Speed USB performance
Display	XGA (1024 x 768 pixels) or higher 65,536 colors or more
Other	Windows Media Player 6.4 or higher must be installed.

Note:

- ATI South Bridge chip set IPX460 or earlier is incompatible with this product.
- Refer to the URLs listed on pages “Help for Users in the United States and Canada” on page 91 and “Help for Users in the Europe (EMEA)” on page 92 for chip sets that are not supported.

Adding the product

Use the EPSON Total Disc Setup to add the product (CD/DVD publisher) to the computer.

Note:

The product must be added when the connection point (port) is set manually. However, the product does not need to be added when the connection point (port) is set automatically.

1. Make sure that the product is connected to the computer via the USB cable and that the product is turned on.
2. Select **Start** ( in Windows 7 or Windows Vista) - **All Programs** (or **Programs**) - **EPSON Total Disc Maker - EPSON Total Disc Setup**.

The EPSON Total Disc Setup will start.

3. Click **Add**.
4. Select [Local CD/DVD publisher], then click **Next**.
5. Select the product to be added from CD/DVD Publisher List, then click **Next**.
6. Enter any name and click **OK**.

Setting Working Folder

Create **Working Folder** on the hard disk for disc publishing operation.

Note:

- ❑ Working Folder *setting is done using Option dialogue of EPSON Total Disc Maker.*
- ❑ Option *dialogue will be displayed when starting EPSON Total Disc Maker for the first time.*

1. Start EPSON Total Disc Maker.
2. Select **Option** from **Tool** menu.

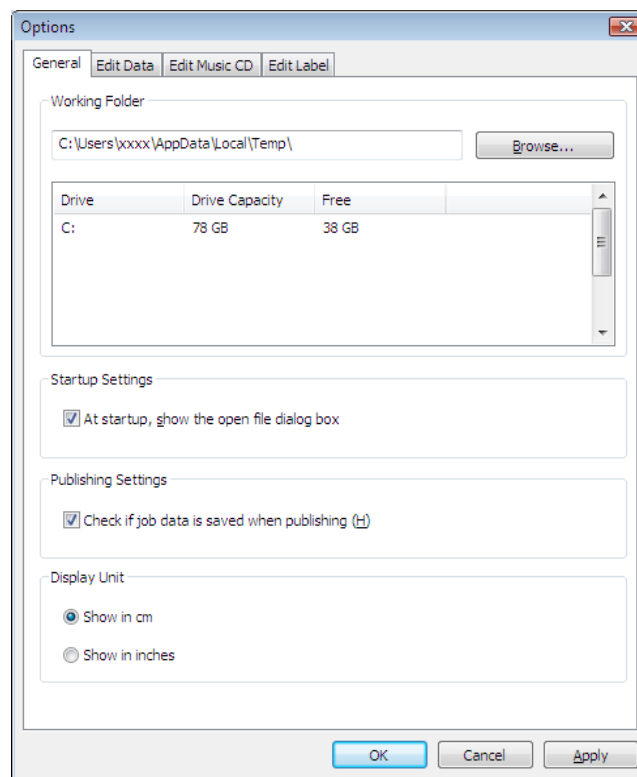

3. Select a folder to create **Working Folder**.

Note:

Select a drive with sufficient free space.

Windows 2000, Windows XP: 10 GB or more

Windows Vista: 25 GB or more

Windows 7: 26 GB or more

4. Click **OK**.

Optional Settings

You can change the settings for the log output and buzzer functions.

Log files saved in the computer connected with the product are useful for service and support of the product. However, to ensure that the hard disk of the computer has sufficient free space, the log output function can be disabled with the following procedure.

You can also change the setting for the buzzer function that lets you know when jobs end with the following procedure.

Note:

- These settings are reflected for all the CD/DVD publishers registered. (Except for the PP-100N)
- When the log files saved in the computer exceeds 200MB, the older ones will be deleted (starting with the oldest one) to make room for new ones.
- Only the PP-100AP has the buzzer function.

1. Start EPSON Total Disc Setup.
2. Select **Common Setting for Publishing** from the **Tool** menu.

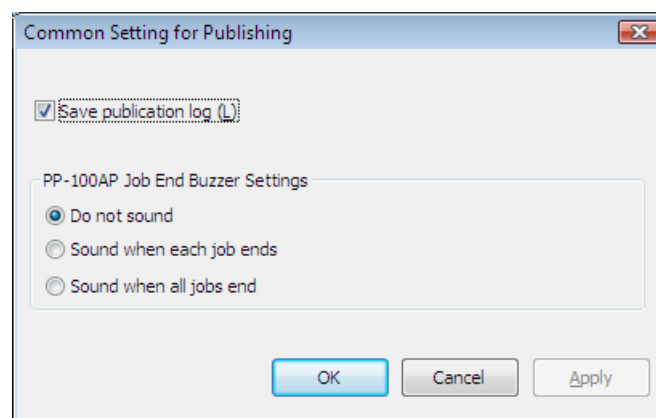

3. Set the log output and buzzer setting.
4. Click **OK**.

Overview of Applications

The EPSON Total Disc Maker software included with the product allows you to create CD/DVD labels and publish CDs/DVDs.

EPSON Total Disc Maker

EPSON Total Disc Maker lets you print CD/DVD labels. The process used to print CD/DVD labels is called "Publish" in the EPSON Total Disc Maker program.

EPSON Total Disc Monitor

EPSON Total Disc Monitor is a utility that monitors the product and gives you information about its current status.

EPSON Total Disc Setup

EPSON Total Disc Setup is a utility to register the product to the computer.

Using EPSON Total Disc Maker

Use EPSON Total Disc Maker to create and edit CD/DVD labels.

Starting EPSON Total Disc Maker

Click **Start** ( in Windows 7 or Windows Vista), point to **All Programs** (Windows 7, Windows Vista or Windows XP) or **Programs** (Windows 2000), point to **EPSON Total Disc Maker**, and then click **EPSON Total Disc Maker**.

Getting information through online help

You can access online help for EPSON Total Disc Maker from the software or from the Windows Start menu.

In EPSON Total Disc Maker window, click the  button to display EPSON Total Disc Maker Help.

Overview of Printer Driver

The printer driver lets you choose from a wide variety of settings to get the best printing results.

Accessing the printer driver

You can access the printer driver from EPSON Total Disc Maker, EPSON Total Disc Setup, most Windows-based applications, and the Windows Start menu.

If displayed from EPSON Total Disc Maker

The settings are only reflected in EPSON Total Disc Maker. The settings are lost when you exit EPSON Total Disc Maker.

If displayed from EPSON Total Disc Setup or the Start menu

The information you set is saved as the printer driver settings, and after this, it is reflected in the printer settings for EPSON Total Disc Maker and all other applications.

Refer to the following sections to access the printer driver.

From EPSON Total Disc Maker

1. Click **Start** ( in Windows 7 or Windows Vista), point to **All Programs** (Windows 7, Windows Vista or Windows XP) or **Programs** (Windows 2000), point to **EPSON Total Disc Maker**, and then click **EPSON Total Disc Maker**.
2. Select **Print Settings** from **Tool** menu.

From EPSON Total Disc Setup

1. Click **Start** ( in Windows 7 or Windows Vista), point to **All Programs** (Windows 7, Windows Vista or Windows XP) or **Programs** (Windows 2000), point to **EPSON Total Disc Maker**, and then click **EPSON Total Disc Setup**.
2. Select CD/DVD Publisher then click **Properties**.

From Windows applications

1. Click **Print** or **Print Setup** in the File menu.
2. In the window that appears, click **Printer**, **Setup**, **Options**, **Preferences**, or **Properties**. (Depending on your application, you may need to click one or a combination of these buttons.)

From the Start menu

1. Windows 7 or Windows Vista:

Click , **Control Panel**, **Hardware and Sound**, then click **Printers**. (If the Control Panel is in Classic View, double-click **Printers**.)

Windows XP:

Click **Start**, **Control Panel**, then click **Printers and Faxes**. (If the Control Panel is in Category View, click **Printers and Other Hardware**, then click **Printers and Faxes**.)

Windows 2000:

Click **Start**, point to **Settings**, then click **Printers** or **Printers and Faxes**.

2. Select EPSON PP-100APPRN, then click **Printing Preferences** in the File menu.

Getting information through online help

You can access online help for items in the printer driver from your application or from the Windows Start menu.

➔ See “Accessing the printer driver” on page 17.

In the printer driver window, try one of the following procedures.

- Right-click the item, then select **Help**.
- Click **Help**.

Uninstalling Software

You can uninstall the software by following the steps below.

Note:

- ❑ *In Windows 7 or Windows Vista, you may be asked for an administrator password or confirmation when uninstalling the software. When asked for a password, enter the password to proceed with the operation.*
- ❑ *In Windows XP, log on with a “computer administrator” account (user with administrator privileges) to uninstall the software.*
- ❑ *In Windows 2000, log on as a user who has administrator authority (user belonging to the administrator group) to uninstall the software.*
- ❑ *When installing the software, various Microsoft components may be installed. Some of them may not be uninstalled when uninstalling the software.*

1. Close all applications.

2. **Windows 7, Windows Vista or Windows XP:**

Click **Start** ( in Windows 7 or Windows Vista), and then select **Control Panel**.

Windows 2000:

Click **Start**, point to **Settings**, and then select **Control Panel**.

3. Click **Uninstall a program** (Windows 7 or Windows Vista) or double-click the **Add or Remove Programs** icon (Windows XP or Windows 2000).
(For Windows Vista, if the Control Panel is in Classic View, double-click the **Programs and Features** icon.)
4. Choose EPSON Total Disc Maker.
5. Click **Uninstall/Change** (Windows 7 or Windows Vista) or click **Change/Remove** (Windows XP or Windows 2000).
6. Select **Remove** and click **Next**.
7. When the confirmation message appears, click **Yes**.
8. Follow the on-screen instructions.

Introduction

This section guides you through the procedures for printing CD/DVD labels.

Note:



For information on CDs/DVDs, see the following section.

➔ See “Discs” on page 96.



Turning power on/off

This section describes how to turn on/off power.

Turning power on

1. Connect the power cable.
2. Press  **power** button until the power light flashes.
 -  Power light flashes in green, then stays on.

Turning power off

Press the  **power** button. The ○  power light will flash in green then turn off; then power is turned off.



Caution:

- ❑ *Fan will operate after turning power off, but it will automatically stop after 15 minutes.*
- ❑ *If the product is operating, wait for 10 seconds after operation is stopped, then turn off power.*
- ❑ *The product may not be recognized by the computer when the power is turned back on while fan is operating. In this case, disconnect the USB cable and connect it again.*

Overview of publishing mode

To print labels that you have created/edited is called “Publish” in EPSON Total Disc Maker. The product has three kinds of publishing modes.

Standard Mode

This mode uses Stacker 1 as the input source, and Stacker 2 or 4 as the output source.

When Stacker 2 is selected as the output source, up to 50 CDs/DVDs can be created at once. Also, if you refill discs to the input stacker and take out published discs from the output stacker at the same time, up to 1000 CDs/DVDs can be published in a single job.

If Stacker 4 is selected as output source, discs can be removed without stopping the product while running a job.

Note:

This mode does not use Stacker 3.

➔ See “Standard Mode” on page 24.

External Output Mode

This mode uses Stacker 1 and 2 as the input sources, and Stacker 4 as the output source.

Different types of discs (CD and DVD) can be loaded into each of the 2 stackers and can create different types of discs. This is ideal for creating small batches of discs at once.

If a same type of discs are loaded into Stacker 1 and 2, up to 1000 CDs/DVDs can be continuously published in a single job by refilling discs and taking out published discs.

Since discs are ejected to Stacker 4, discs can be removed without stopping the product while running a job.

Note:

This mode does not use Stacker 3.

➔ See “External Output Mode” on page 33.

Batch Mode

This mode uses Stacker 1 and 2 as the input sources, and Stacker 2 and 3 as the output sources.

You can create up to 100 CDs/DVDs at once without refilling and taking out discs while publishing. Up to 1000 CDs/DVDs can be continuously published in a single job by refilling discs and taking out published discs. To use this mode, you need to place Stacker 3 into the product.

➔ See “Batch Mode” on page 43.

Notice for CD/DVD label printing

- ❑ Store the stacker out of direct sunlight. A warped or damaged stacker may stop the product from operating normally.
- ❑ Use only CDs/DVDs labeled as suitable for printing, for example “Printable on the label surface” or “Printable with ink jet printers.”
- ❑ For more details on handling CDs/DVDs, refer to your CD/DVD documentation.
- ❑ When using the product for the first time after storing it for a long time or after an error, missing dots or ink stains may appear and print quality may be reduced. If publishing a large number of discs, check print quality by publishing one disc in advance. If any dots are missing, run Head Cleaning.
- ❑ Printing on rib area may result in ink sticking, disc sticking, or color loss.
- ❑ Try to test print on a spare CD/DVD, and check the printed surface after waiting for one full day, especially before printing a large number of CDs/DVDs.
- ❑ After printing the first copy, check the print quality to see if any dots are missing.
- ❑ Before using or touching the printed surface of your CDs/DVDs, make sure they are completely dry and keep them out of direct sunlight.
- ❑ If the printed surface is sticky even after it has dried, do the following.
 1. Change label type.
 2. Change color saturation level.
 3. Change the disc.
- ❑ Moisture on the printable surface may cause smearing.
- ❑ When using Epson specified discs, only [1] can be selected for Print Mode setting.
- ❑ Reprinting on the same CD/DVD may not improve the print quality.
- ❑ Be sure to clean the inside of the stacker before using if there are any dirt.
- ❑ Please check disc before printing, as the size of the receptor may vary.
- ❑ Ink may not bond if printed outside the receptor.
- ❑ If the product is operating, wait for 10 seconds after the operation is finished, and then turn the power off.
- ❑ The quality of the disc determines print quality. It is recommended to use only the specified disc type.

- Do not use a cracked, warped, or deformed discs because it may break in pieces inside the product and cause malfunction or injury.
- A disc may become unreadable or unwritable if it has a small scratch or dirt; therefore, please handle it with care.
- Do not touch both surfaces when holding a disc.
- The completed job display of EPSON Total Disc Monitor shows the number of successes, number of failures, and number of discs printed.
- Do not use discs with lens cleaner, CD/DVD label sticker, or condensation on them as it may cause mechanical error or malfunction.

Printing on CDs/DVDs with a commercially available software package

When you print on CDs/DVDs with a commercially available software package that supports CD/DVD printing, you have to make the following settings.

Size	124 x 124 mm (4.88 x 4.88")
Type	CD/DVD Label, CD/DVD Premium Label, or Epson Specified CD/DVD Label
Margins on all sides	2 mm (0.08")

Notice for barcode printing

- When printing barcodes and 2D codes, be sure to use Epson brand ink cartridges.
- When printing barcodes and 2D codes on discs that are not Epson specified CD/DVDs, check whether the printed barcodes or 2D codes can be read correctly by a scanner.
- Do not place barcodes or 2D codes where they overlap other print data, or where they extend beyond the print area.
- Barcodes and 2D codes use the ratio of black to white to indicate information. If ink penetration results in a deterioration of the ratio of black to white, barcodes and 2D codes may not be able to be read correctly. Check whether the printed barcodes and 2D codes can be read correctly by a scanner.
- If a barcode printed with bidirectional printing cannot be read correctly, align the print head and then print the barcode, or print the barcode with unidirectional printing.

Standard Mode

Loading CDs/DVDs

Follow the steps below to load CDs/DVDs.

1. Open the disc cover.

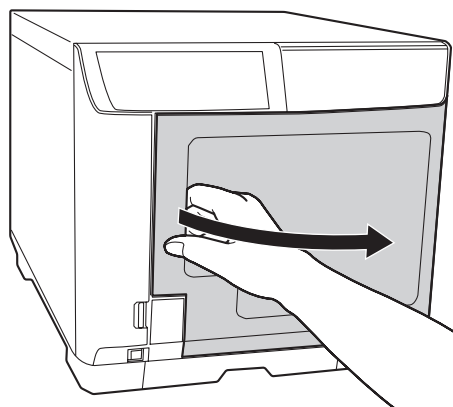

2. Take out Stacker 1.

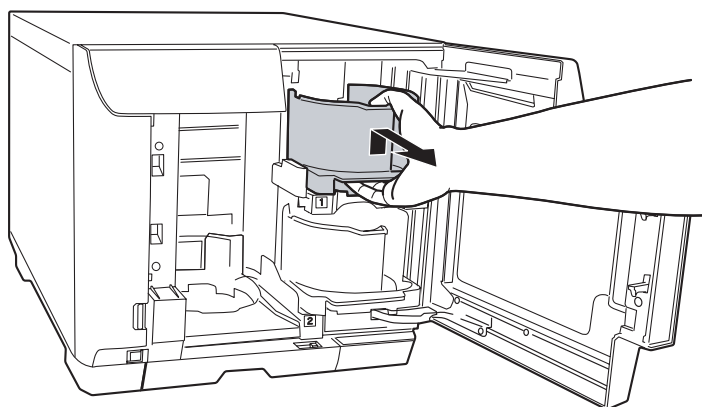

3. Fan a stack of discs to prevent them from sticking together. Be careful not to scratch the recording side of the disc.

4. Load CDs/DVDs into Stacker 1 with the printable side facing up.

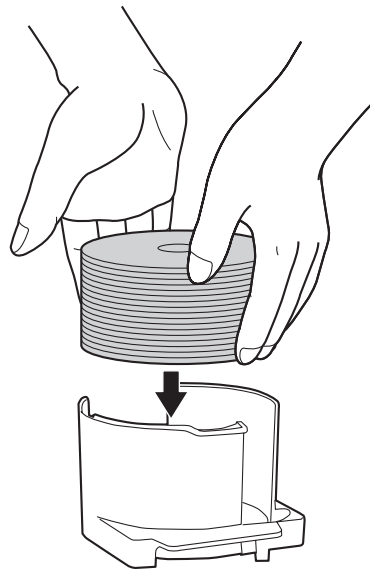

Caution:

Do not load the discs above the red line marked on the stacker; otherwise, the discs or product may be damaged.

5. Insert Stacker 1.

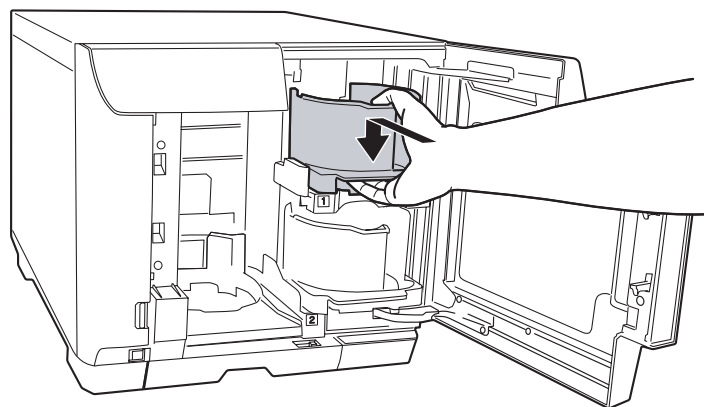

6. Close the disc cover.

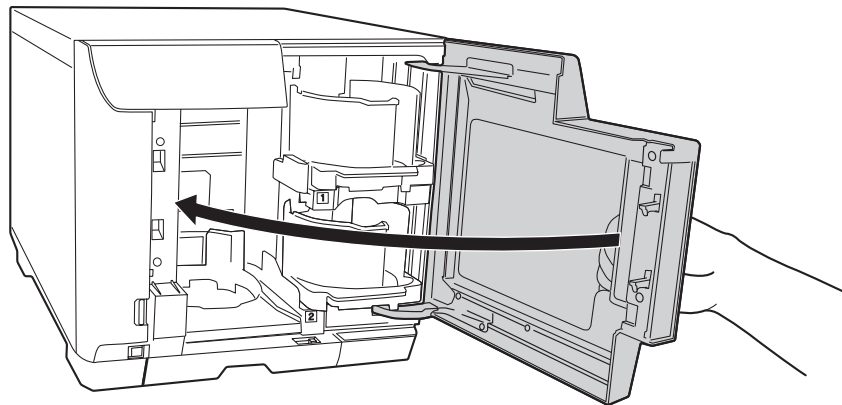

Caution:

- ❑ Do not yank Stacker 4 when pulling it out to remove published discs.
- ❑ Do not pull out Stacker 4 when the Stacker 4 LED is flashing fast. Discs may be damaged.
- ❑ Unlock the lock lever when using Stacker 4.

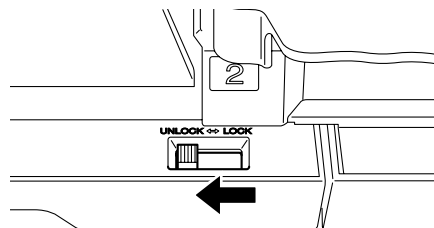

- ❑ Do not install Stacker 3.

Accessing EPSON Total Disc Maker

After loading discs into the stacker, access EPSON Total Disc Maker by following the instruction below to create the labels printed on the discs.

Click **Start** ( in Windows 7 or Windows Vista), point to **All Programs** (Windows 7, Windows Vista, or Windows XP) or **Programs** (Windows 2000), point to **EPSON Total Disc Maker**, and then click **EPSON Total Disc Maker**.

To learn how to use EPSON Total Disc Maker, go to the Help menu.

Creating labels

The following instructions explain how to create labels using templates provided with the software.

1. Click **Label** on the menu bar of EPSON Total Disc Maker.

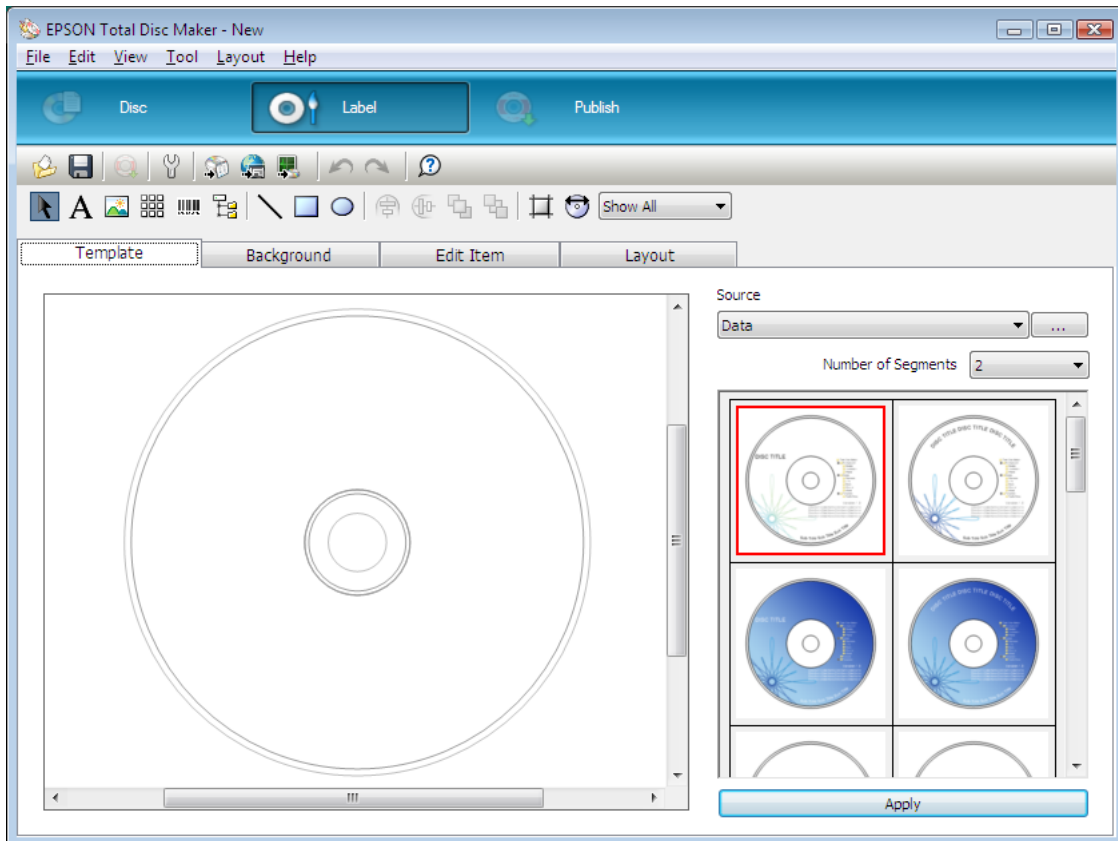

2. Click **Template** tab and select a label design from the list, then click **Apply**.

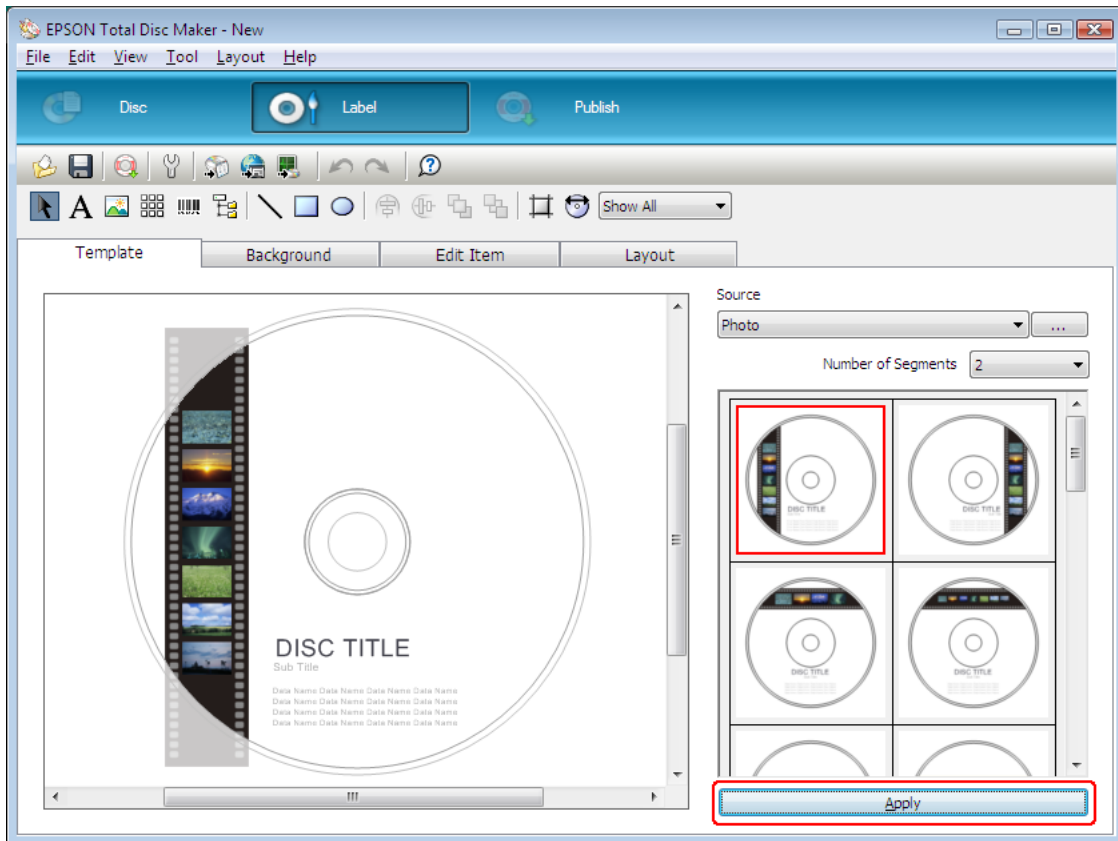

3. Make changes on the label as needed in the **Background**, **Edit Item**, and **Layout** tabs. For details, see **Help** for EPSON Total Disc Maker.

Note:

To access Help for EPSON Total Disc Maker, select **Help** from the Help menu.

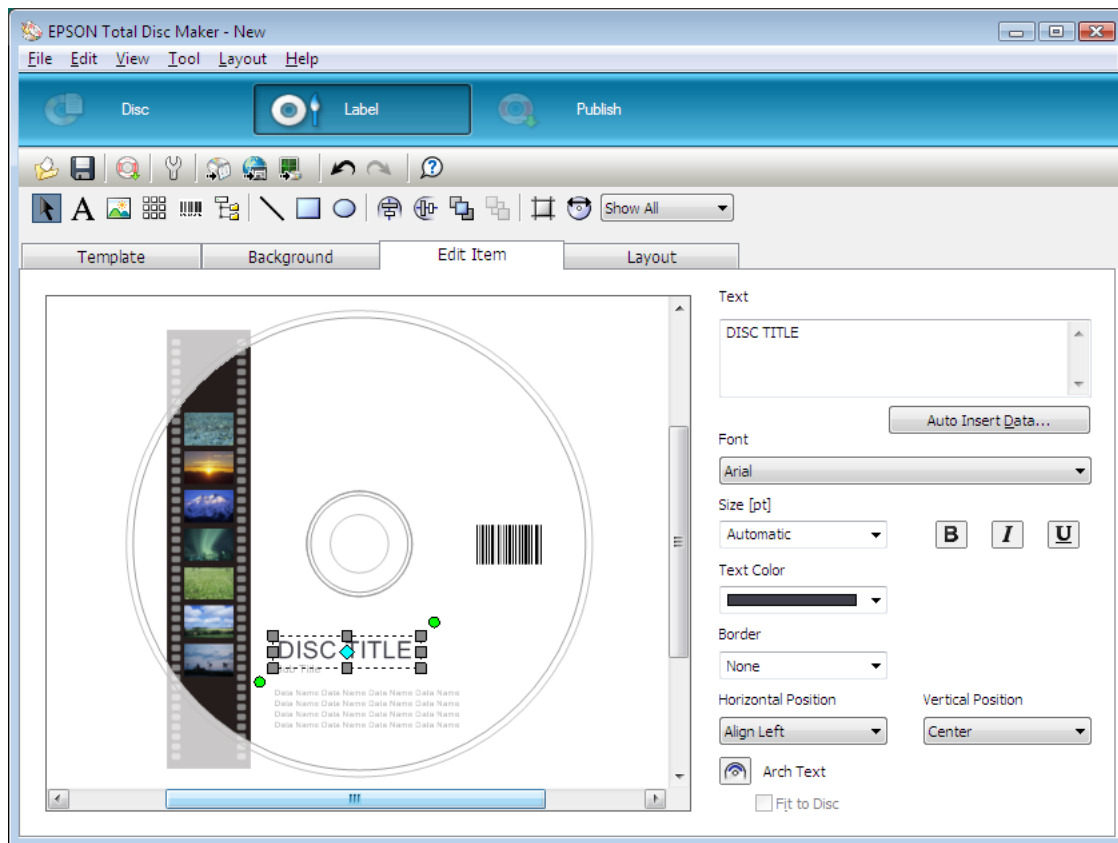

Setting the Publish Mode

The following instructions explain how to set the publish mode.

1. Click **Publish** on the menu bar of EPSON Total Disc Maker.
2. Click **Properties** on the Publish screen of EPSON Total Disc Maker or EPSON Total Disc Setup.

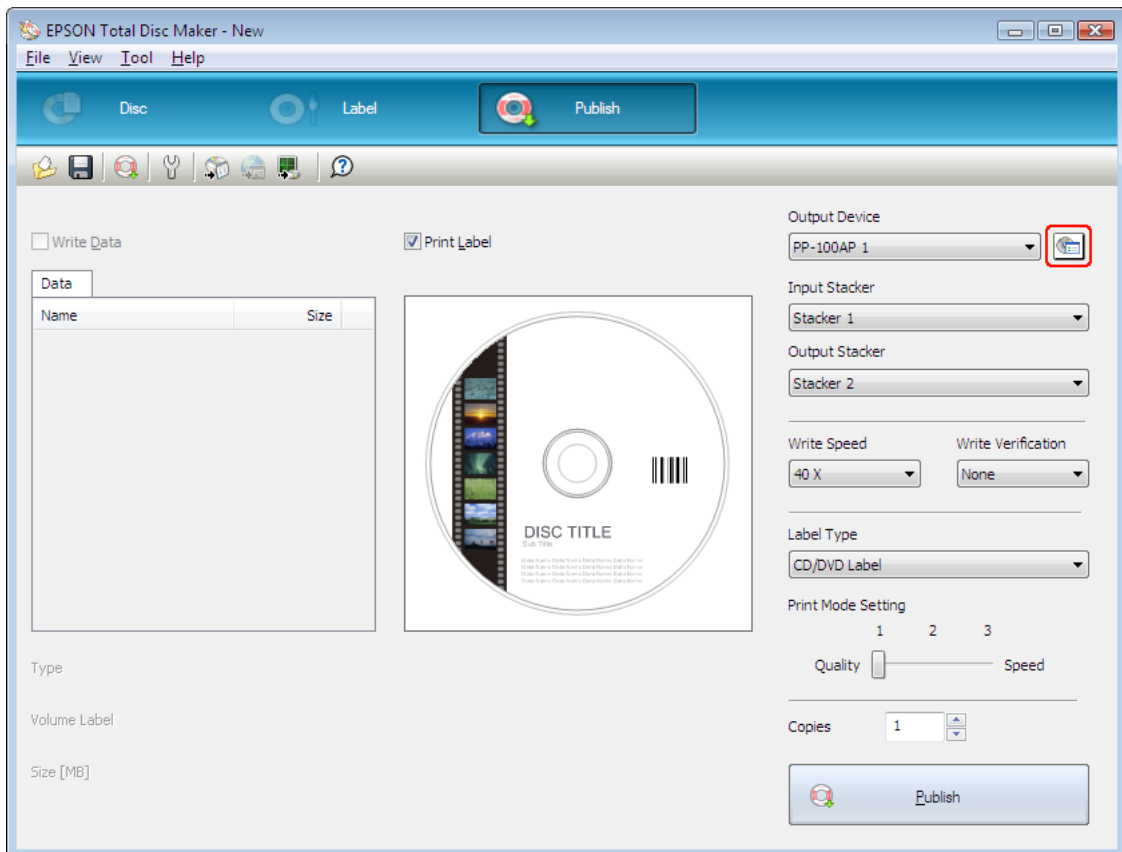

3. Select **Standard Mode** for Publish Mode.

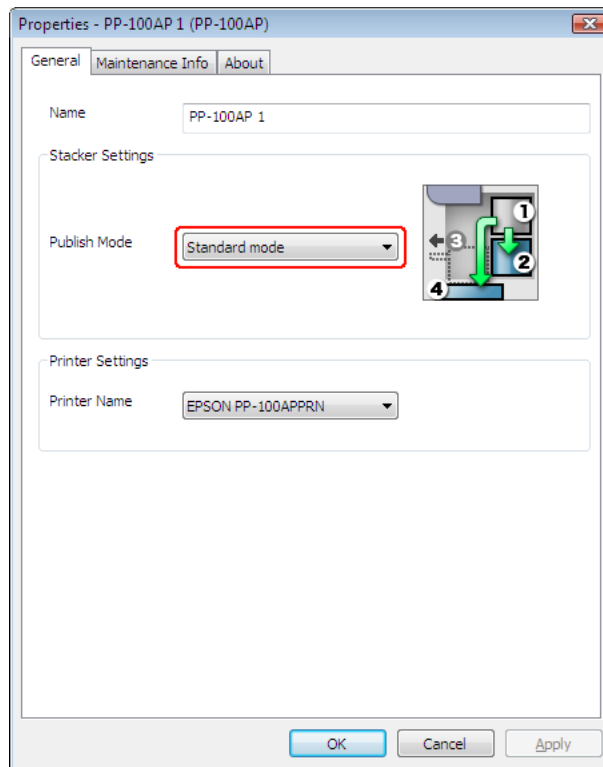

4. Click **OK**.

Publishing Discs

The following instructions explain how to publish CDs/DVDs.

1. Make the publish settings on the Publish screen of EPSON Total Disc Maker. For details, see Help for EPSON Total Disc Maker.

Note:

To access Help for EPSON Total Disc Maker, select **Help** from the Help menu.

2. Click the **Publish** button.

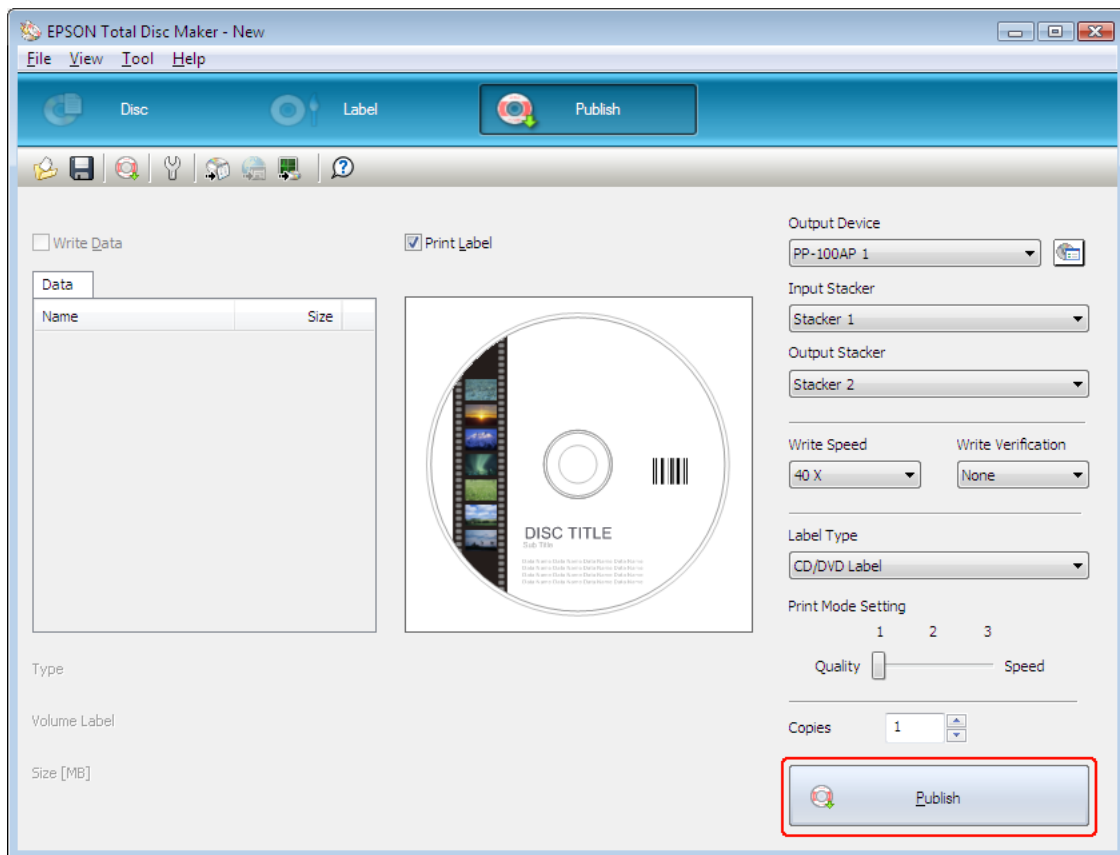

Caution:

- When you have opened the disc cover while running a job (busy indicator is flashing), make sure that internal light has turned off and that the arm has stopped moving before performing any operation such as loading or taking out discs. Do not put your hands inside the product or operate stackers while the arm is moving. Also, open and close the disc cover gently.
- When you open the disc cover while running a job, the job will pause. Closing the disc cover automatically resume the job.
- Do not open the ink cartridge cover or maintenance box cover while running a job.

Note:

If Windows shuts down while processing a job, the job may be resumed when restarting Windows next time.

External Output Mode

Loading CDs/DVDs

Follow the steps below to load CDs/DVDs.

1. Open the disc cover.

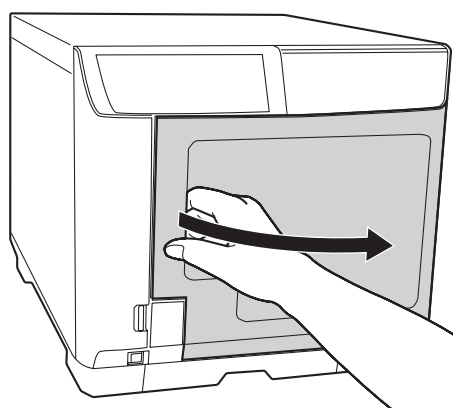

2. Take out Stacker 1.

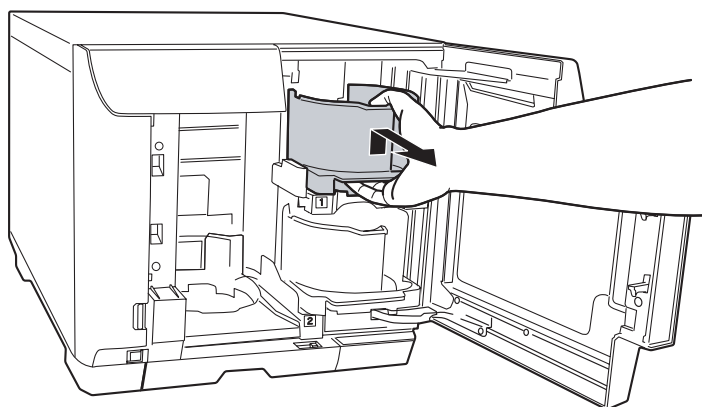

3. Fan a stack of discs to prevent them from sticking together. Be careful not to scratch the recording side of the disc.

4. Load CDs/DVDs into Stacker 1 with the printable side facing up.

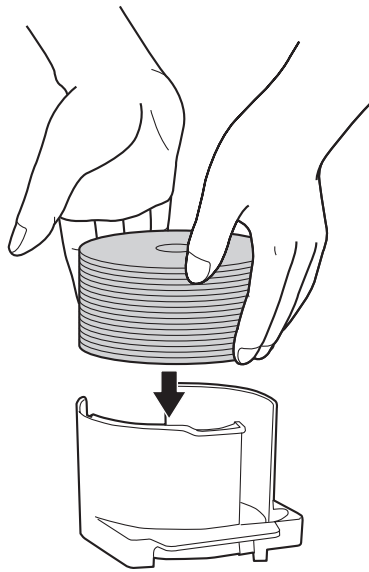

Caution:

Do not load the discs above the red line marked on the stacker; otherwise, the discs or product may be damaged.

5. Insert Stacker 1.

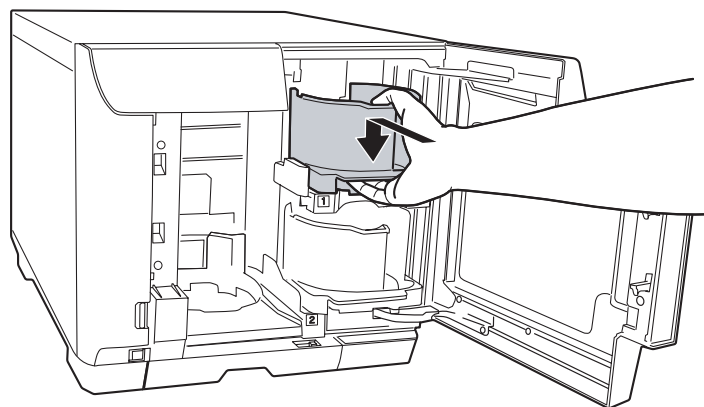

6. Take out Stacker 2.

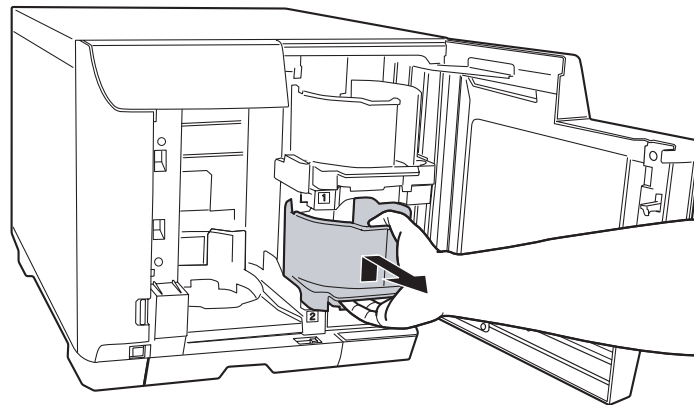

7. Fan a stack of discs to prevent them from sticking together. Be careful not to scratch the recording side of the disc.
8. Load CDs/DVDs into Stacker 2 with the printable side facing up.

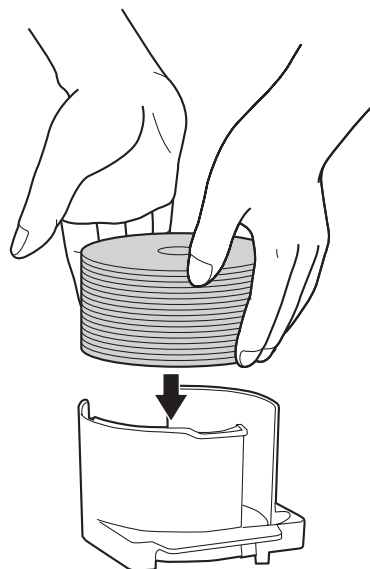

Caution:

Do not load the discs above the red line marked on the stacker; otherwise, the discs or product may be damaged.

9. Insert Stacker 2.

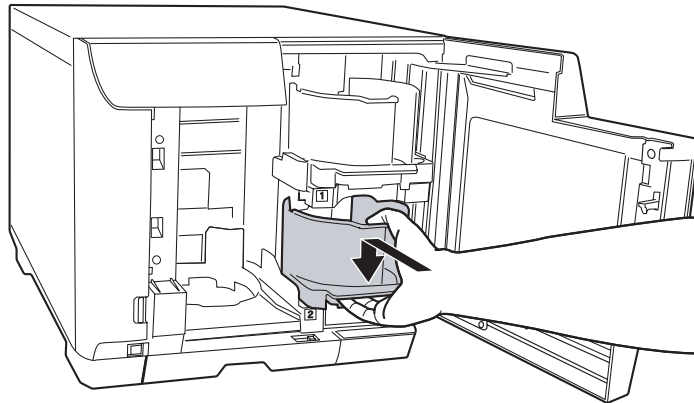

10. Close the disc cover.

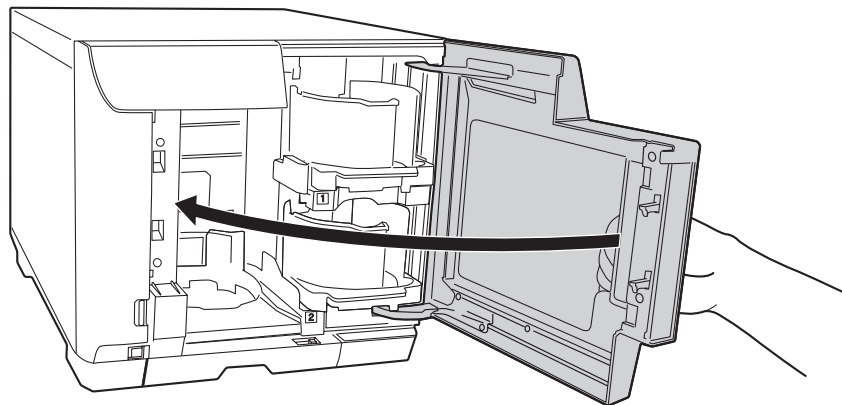

Caution:

- ❑ Do not yank Stacker 4 when pulling it out to remove published discs.
- ❑ Do not pull out Stacker 4 when the Stacker 4 LED is flashing fast. Discs may be damaged.
- ❑ Do not install Stacker 3.

Accessing EPSON Total Disc Maker

After loading discs into the stackers, access EPSON Total Disc Maker by following the instruction below to create the labels printed on the discs.

Click **Start** ( in Windows 7 or Windows Vista), point to **All Programs** (Windows 7, Windows Vista, or Windows XP) or **Programs** (Windows 2000), point to **EPSON Total Disc Maker**, and then click **EPSON Total Disc Maker**.

To learn how to use EPSON Total Disc Maker, go to the Help menu.

Creating labels

The following instructions explain how to create labels using templates provided with the software.

1. Click **Label** on the menu bar of EPSON Total Disc Maker.

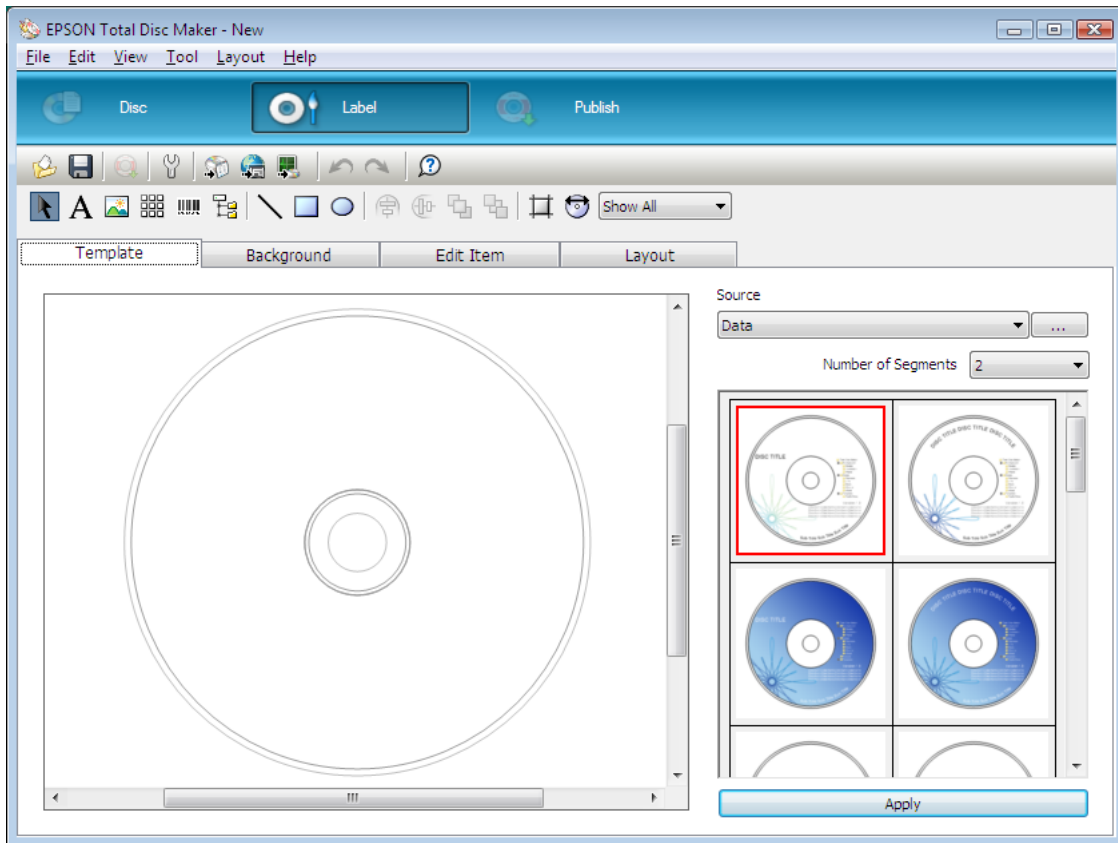

2. Click **Template** tab and select a label design from the list, then click **Apply**.

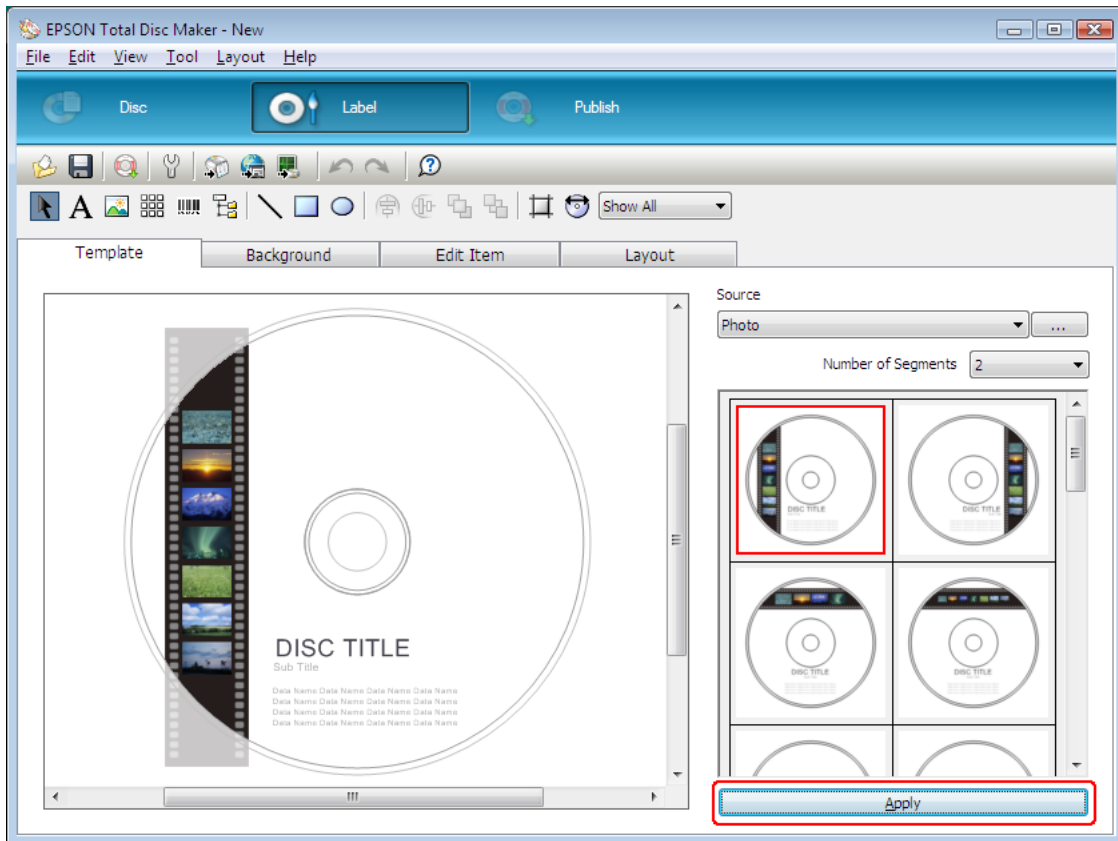

3. Make changes on the label as needed in the **Background**, **Edit Item**, and **Layout** tabs. For details, see **Help** for EPSON Total Disc Maker.

Note:

To access Help for EPSON Total Disc Maker, select **Help** from the Help menu.

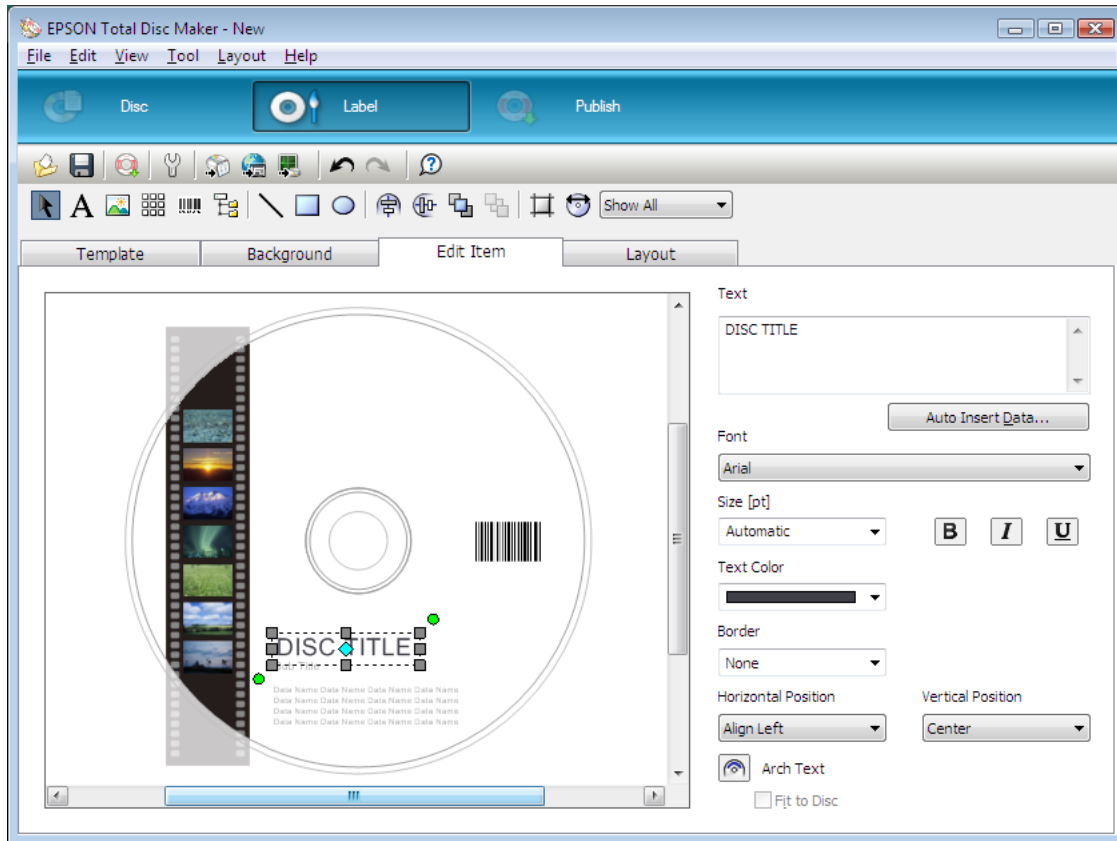

Setting the Publish Mode

The following instructions explain how to set the publish mode.

1. Click **Publish** on the menu bar of EPSON Total Disc Maker.
2. Click **Properties** on the Publish screen of EPSON Total Disc Maker or EPSON Total Disc Setup.

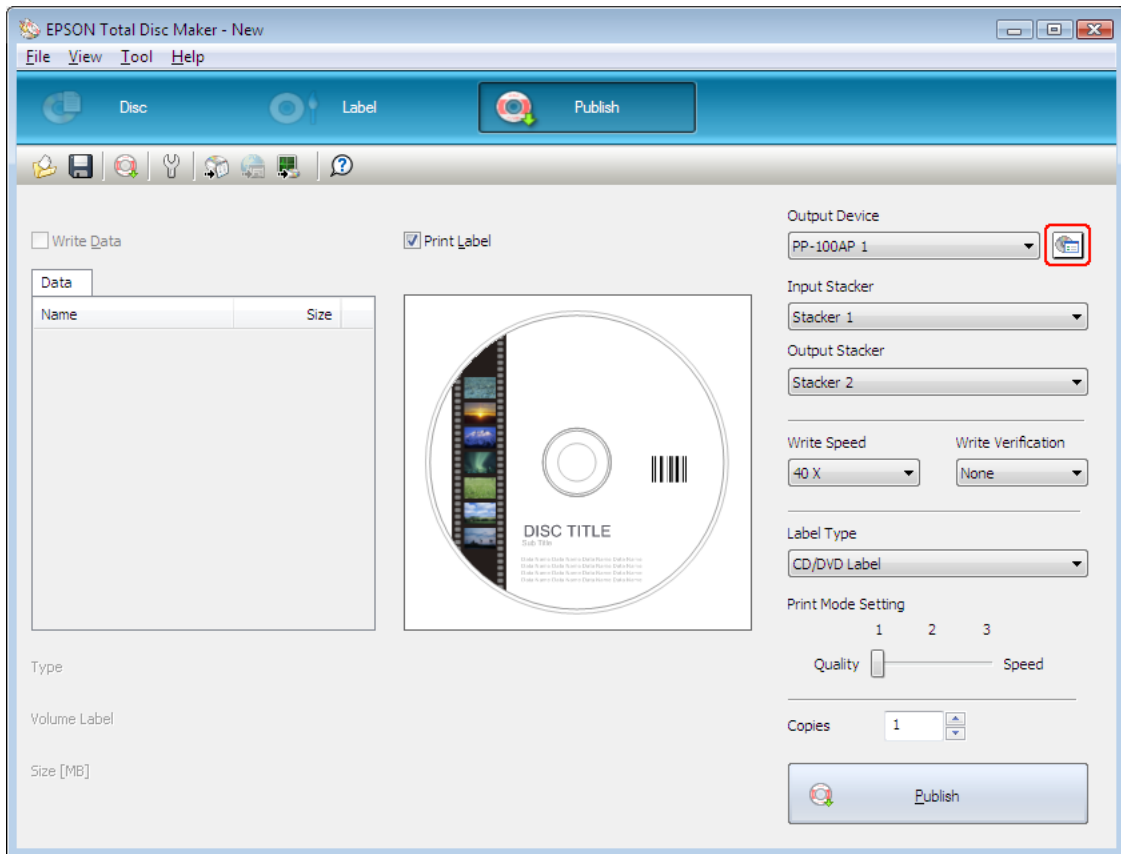

3. Select **External Output Mode** for Publish Mode.

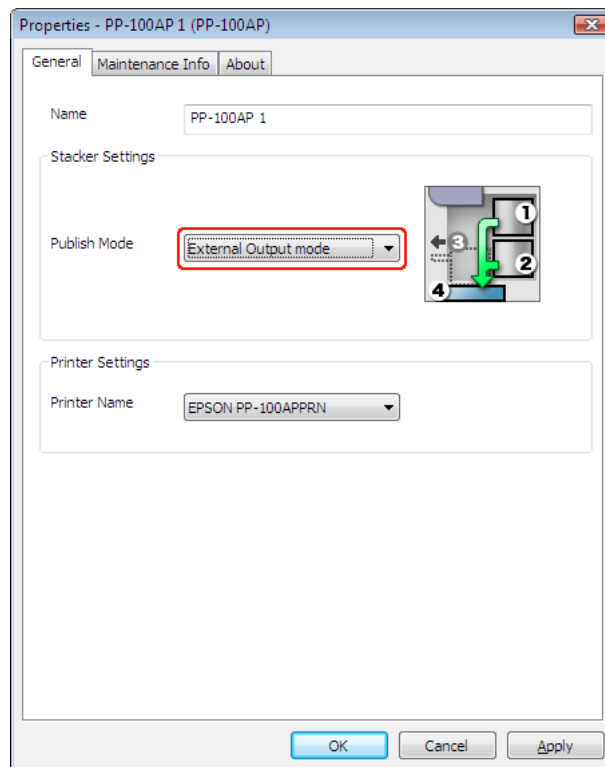

4. Click **OK**.

Publishing Discs

The following instructions explain how to publish CDs/DVDs.

1. Make the publish settings on the Publish screen of EPSON Total Disc Maker. For details, see Help for EPSON Total Disc Maker.

Note:

To access Help for EPSON Total Disc Maker, select **Help** from the Help menu.

2. Click the **Publish** button.

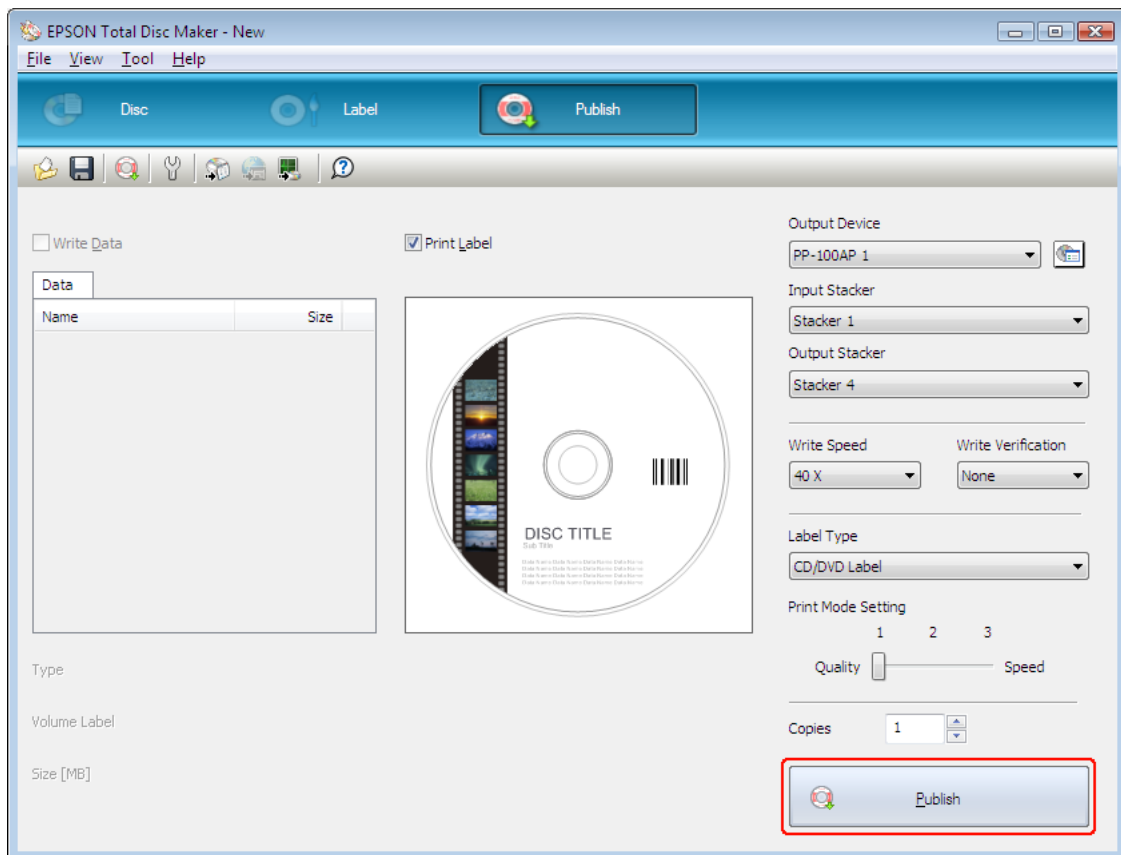

Caution:

- ❑ *When you have opened the disc cover while running a job (busy indicator is flashing), make sure that internal light has turned off and that the arm has stopped moving before performing any operation such as loading or taking out discs. Do not put your hands inside the product or operate stackers while the arm is moving. Also, open and close the disc cover gently.*
- ❑ *When you the open disc cover while running a job, the job will pause. Closing the disc cover automatically resume the job.*
- ❑ *Do not open the ink cartridge cover or maintenance box cover while running a job.*

Note:

If Windows shuts down while processing a job, the job may be resumed when restarting Windows next time.

Batch Mode

Loading CDs/DVDs

Follow the steps below to load CDs/DVDs.

1. Open the disc cover.

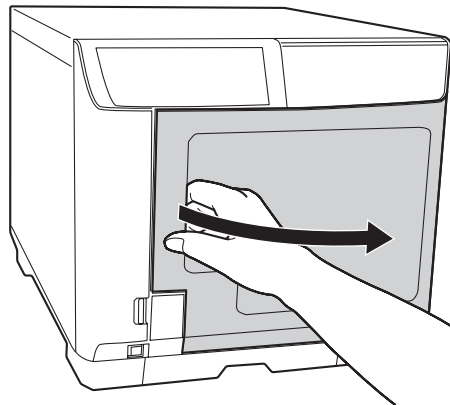

2. Take out Stacker 1.

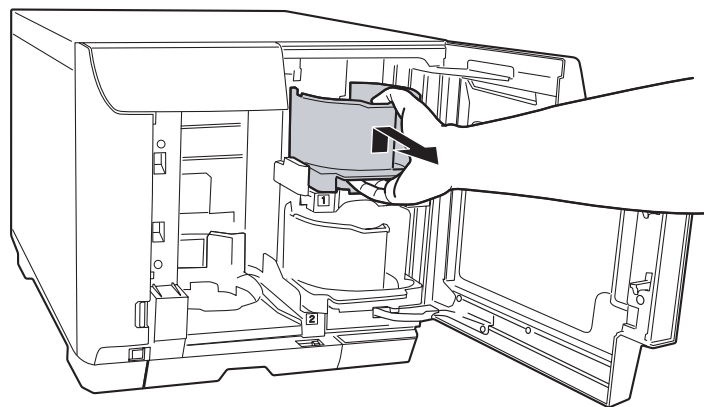

3. Fan a stack of discs to prevent them from sticking together. Be careful not to scratch the recording side of the disc.

4. Load CDs/DVDs into Stacker 1 with the printable side facing up.

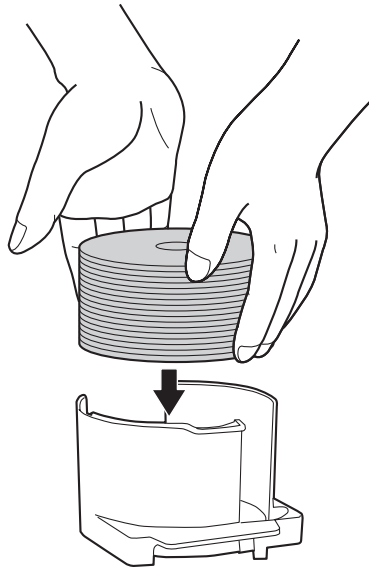

Caution:

Do not load the discs above the red line marked on the stacker; otherwise, the discs or product may be damaged.

5. Insert Stacker 1.

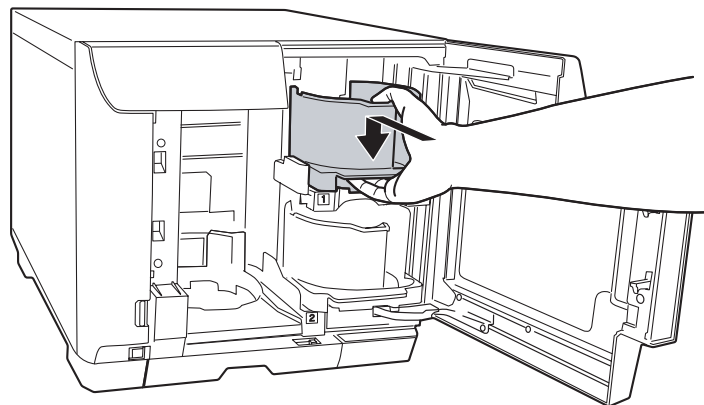

6. Take out Stacker 2.

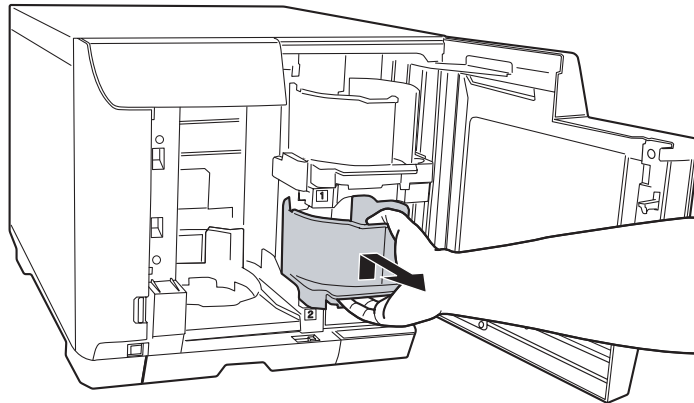

7. Fan a stack of discs to prevent them from sticking together. Be careful not to scratch the recording side of the disc.
8. Load CDs/DVDs into Stacker 2 with the printable side facing up.

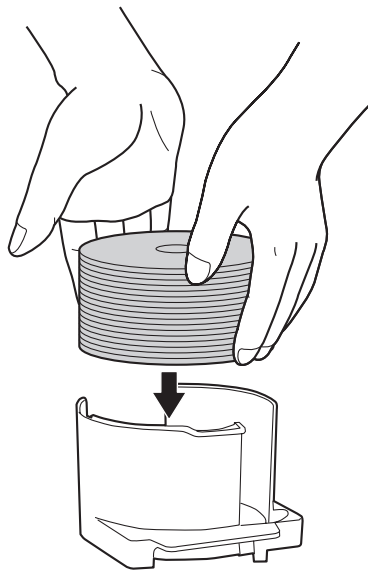

Caution:

Do not load the discs above the red line marked on the stacker; otherwise, the discs or product may be damaged.

9. Insert Stacker 2.

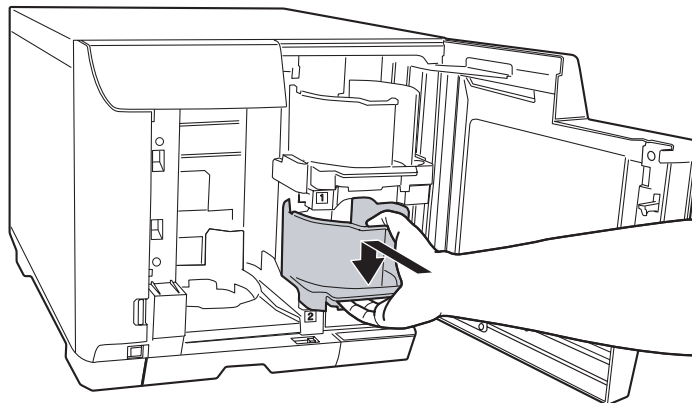

10. Insert Stacker 3.

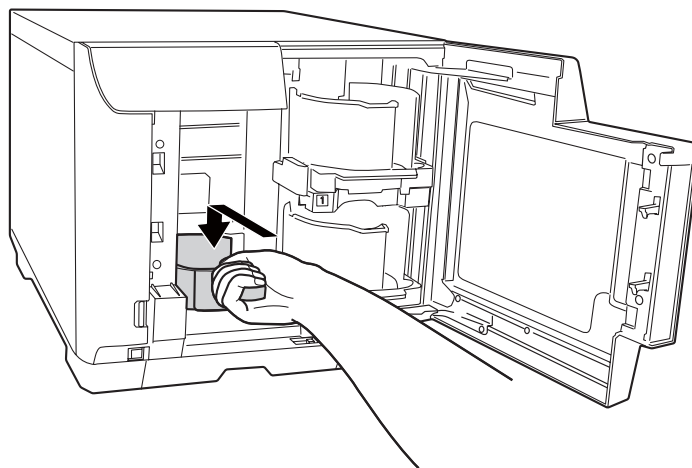

Caution:

- ❑ Make sure that there are no discs in Stacker 3 and 4.
- ❑ Do not pull out Stacker 4. Be sure to lock the lock lever located on Stacker 4.

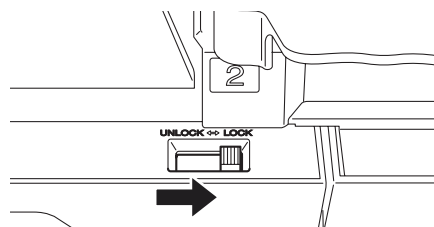

11. Close the disc cover.

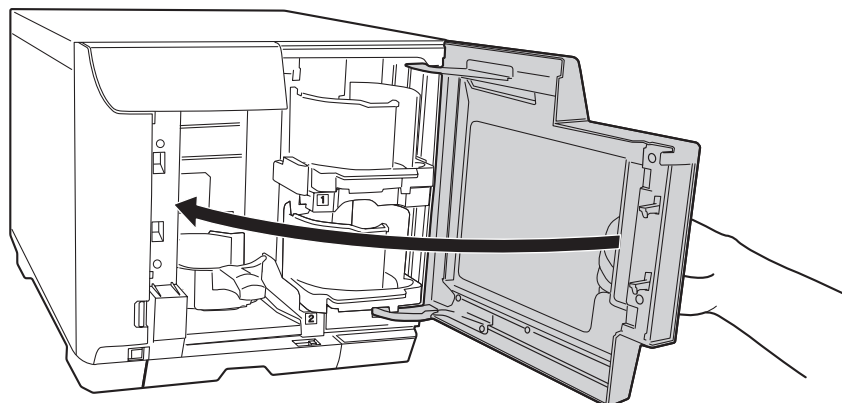

Accessing EPSON Total Disc Maker

After loading discs into the stackers, access EPSON Total Disc Maker by following the instruction below to create the labels printed on the discs.

Click **Start** ( in Windows 7 or Windows Vista), point to **All Programs** (Windows 7, Windows Vista, or Windows XP) or **Programs** (Windows 2000), point to **EPSON Total Disc Maker**, and then click **EPSON Total Disc Maker**.

To learn how to use EPSON Total Disc Maker, go to the Help menu.

Creating labels

The following instructions explain how to create labels using templates provided with the software.

1. Click **Label** on the menu bar of EPSON Total Disc Maker.

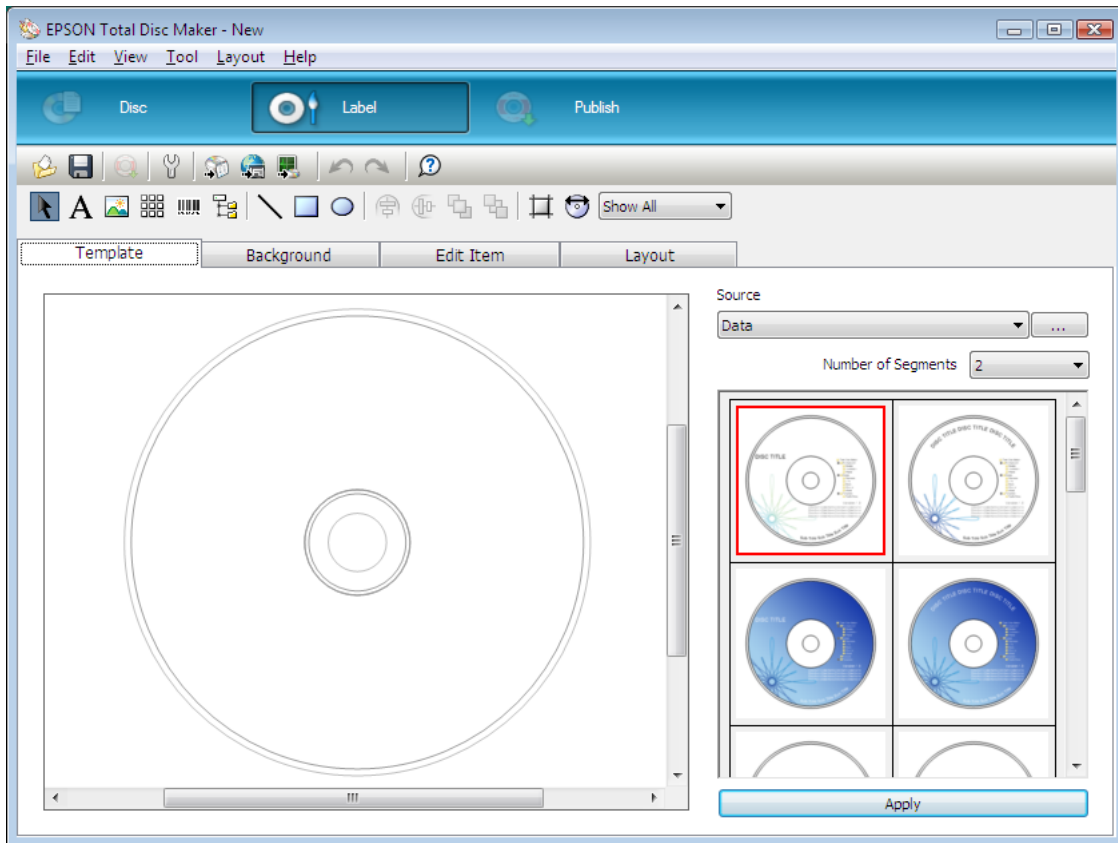

2. Click **Template** tab and select a label design from the list, then click **Apply**.

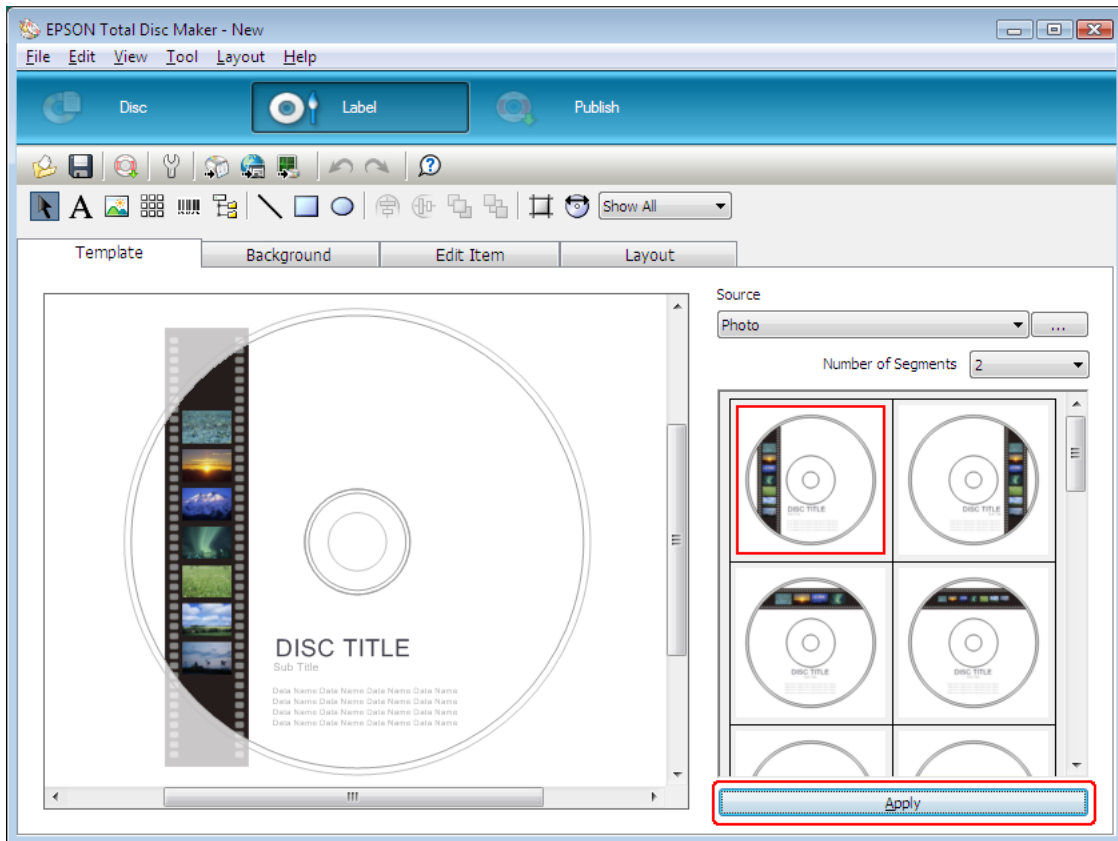

3. Make changes on the label as needed in the **Background**, **Edit Item**, and **Layout** tabs. For details, see **Help** for EPSON Total Disc Maker.

Note:

To access Help for EPSON Total Disc Maker, select **Help** from the Help menu.

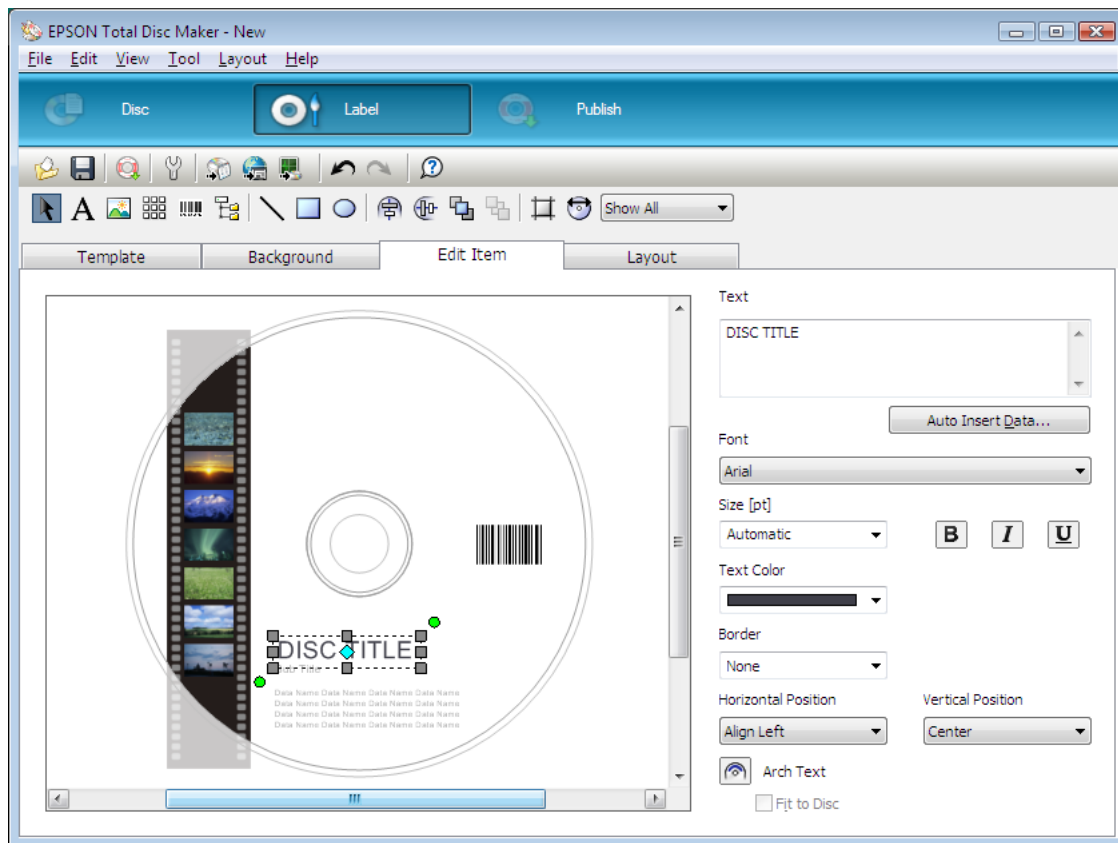

Setting the Publish Mode

The following instructions explain how to set the publish mode.

1. Click Publish on the menu bar of EPSON Total Disc Maker.
2. Click **Properties** on the Publish screen of EPSON Total Disc Maker or EPSON Total Disc Setup.

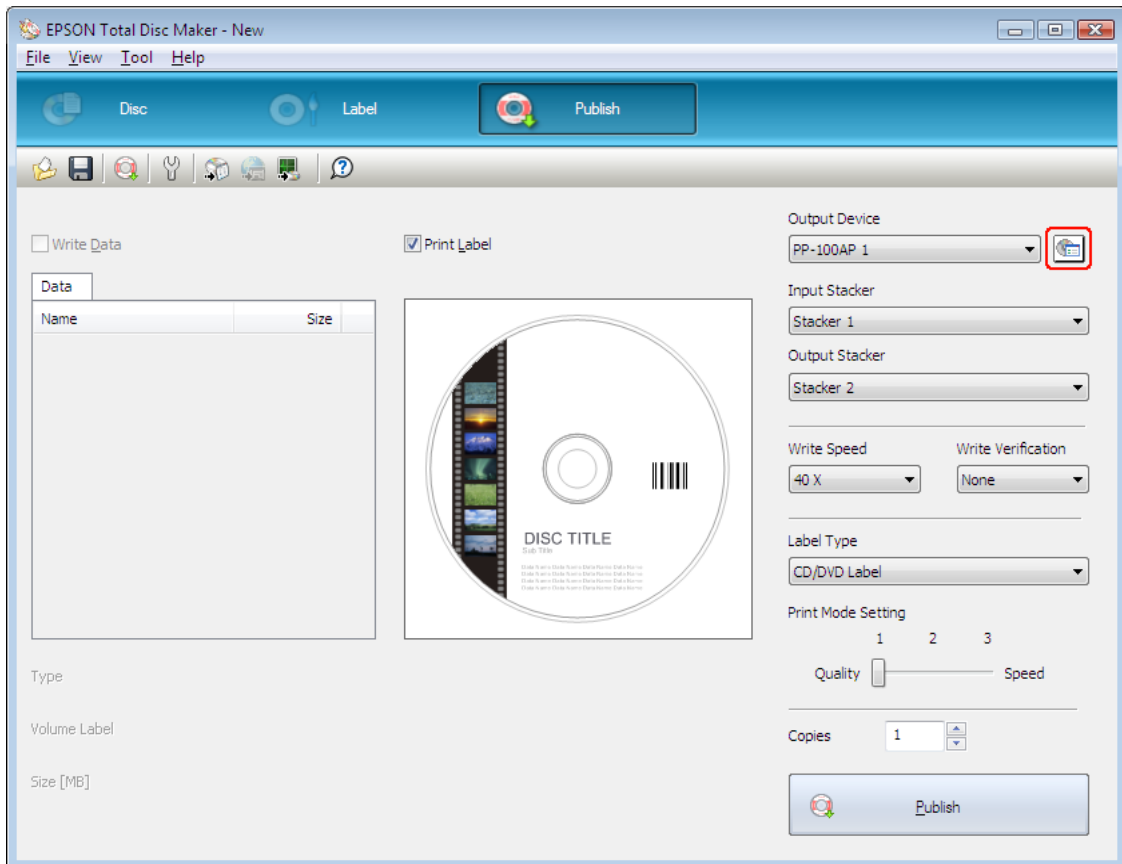

3. Select **Batch Mode** for Publish Mode.

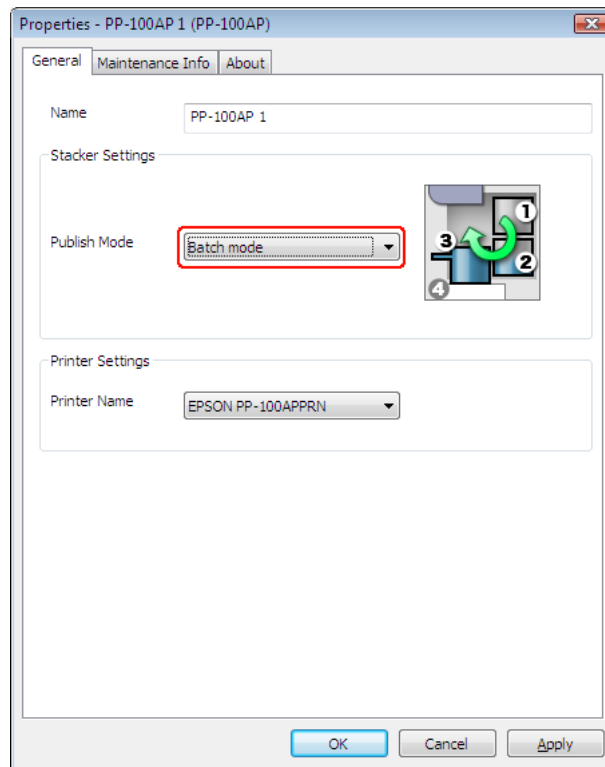

4. Click **OK**.

Publishing Discs

1. Make the publish settings on the Publish screen of EPSON Total Disc Maker. For details, see Help for EPSON Total Disc Maker.

Note:

To access Help for EPSON Total Disc Maker, select **Help** from the Help menu.

2. Click the **Publish** button.

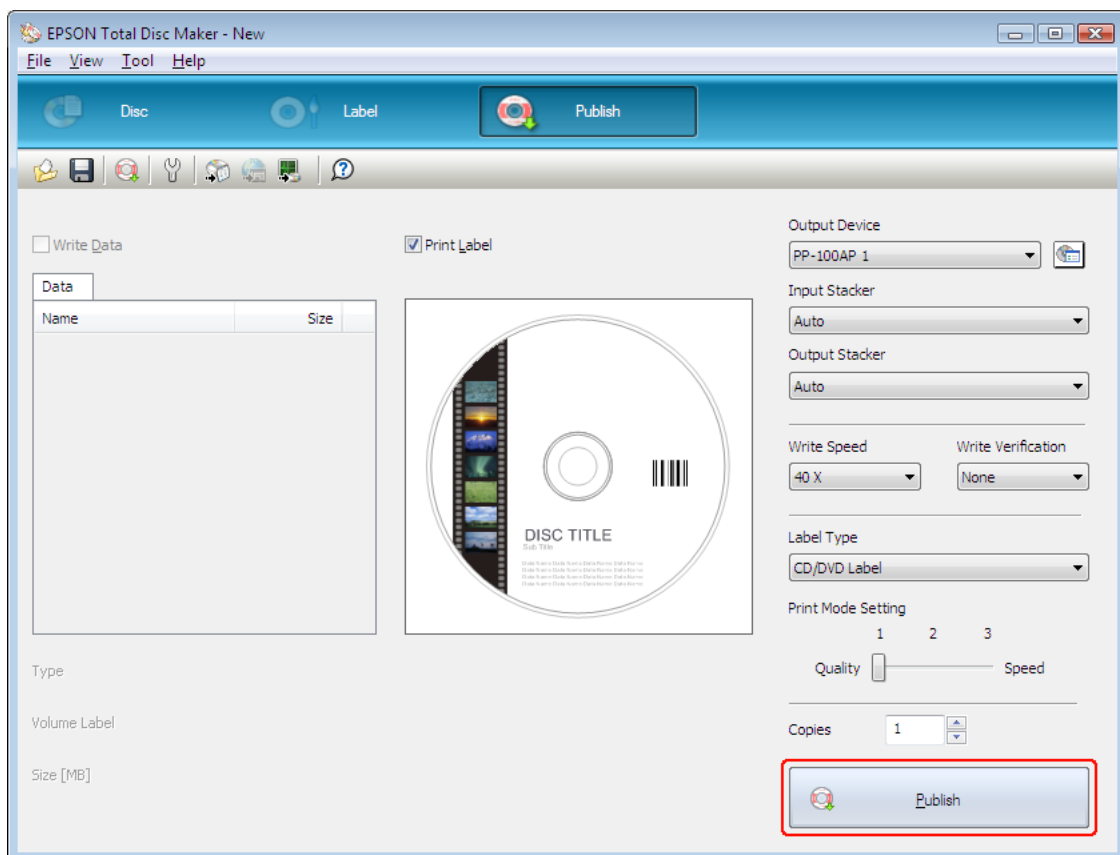

Caution:

- When you have opened the disc cover while running a job (busy indicator is flashing), make sure that internal light has turned off and that the arm has stopped moving before performing any operation such as loading or taking out discs. Do not put your hands inside the product or operate stackers while the arm is moving. Also, open and close the disc cover gently.
- When you open the disc cover while running a job, the job will pause. Closing the disc cover automatically resume the job.
- Do not open the ink cartridge cover or maintenance box cover while running a job.

Note:

If Windows shuts down while processing a job, the job may be resumed when restarting Windows next time.

Taking Out Discs

Follow the steps below to take out the published discs from the stackers.

1. Open the disc cover (only for output to Stacker 2 or 3), and take out the stacker.
2. Take out the published discs from the stacker. The output stacker differs according to the publishing mode. Refer to the following table.

Output stacker	Mode	Number of discs
Stacker 2	Standard mode Batch mode	Up to about 50 discs
Stacker 3	Batch mode	Up to about 50 discs
Stacker 4	Standard mode External Output mode	Up to about 5 discs

Stacker 2

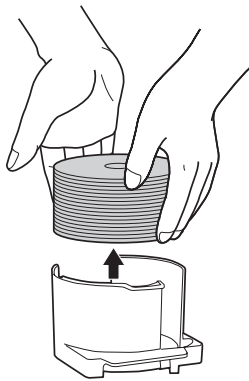

Stacker 3

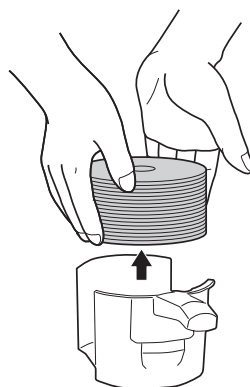

Stacker 4

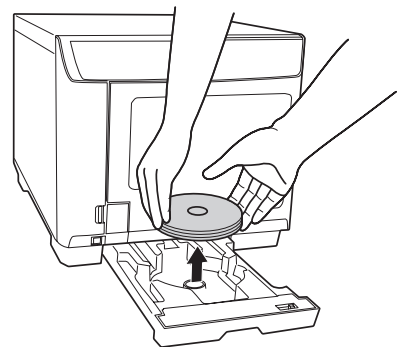

Note:

- ❑ Be sure to let CDs and DVDs dry completely before using them or touching the printed surface. Allow Epson specified discs to dry for at least 1 hour and other types of discs for at least 24 hours.
- ❑ If the print position is misaligned, adjust it using the printer driver. For details, refer to the printer driver Help.
- ❑ If the ink smears, adjust the color saturation. For details, refer to the printer driver Help.
- ❑ When publishing discs using Batch Mode, the number of discs output to Stacker 3 is not always the same with the number of discs set to Stacker 2. Also, the number of discs does not always become 50. The same applies to the number of discs output to Stacker 2. For Batch mode, the output stacker switches to Stacker 2 when the ejected discs accumulated in Stacker 3 reach the height limit. As a result, the number of discs output to the stacker depends on the thickness of the discs used.

Pausing Publishing

If you need to pause publishing, follow the instructions below.

When you start publishing, the screen of EPSON Total Disc Monitor appears on your computer screen. Select the job you want to pause in the Unfinished Job list, and then select **Pause Job** from the Job menu or click  button.

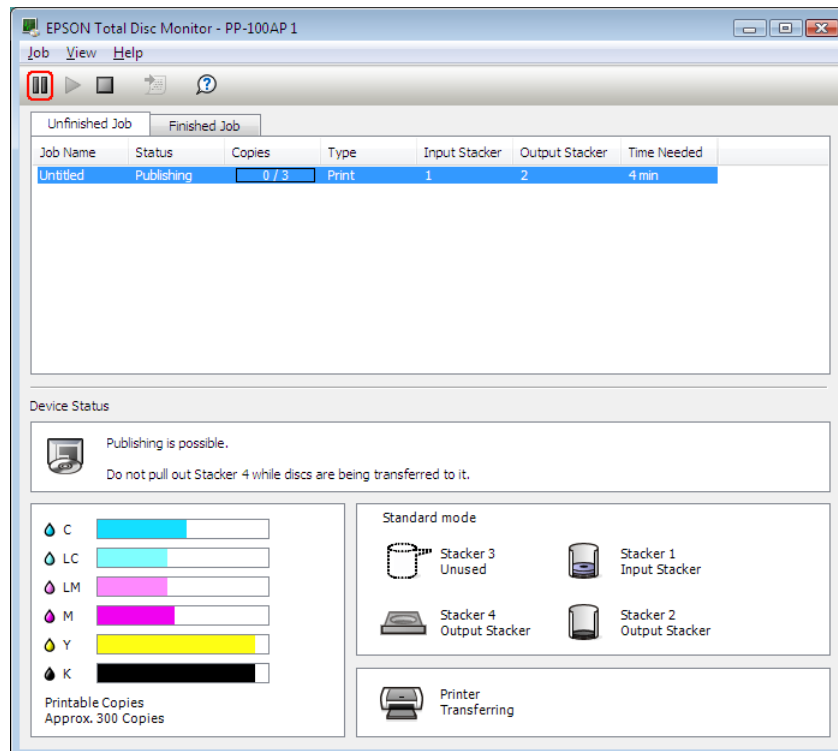

Resuming Publishing

If you need to cancel publishing, follow the instructions below.

Start EPSON Total Disc Monitor. Select the job you want to resume in the Unfinished Job list, and then select **Resume Job** from the Job menu or click  button.

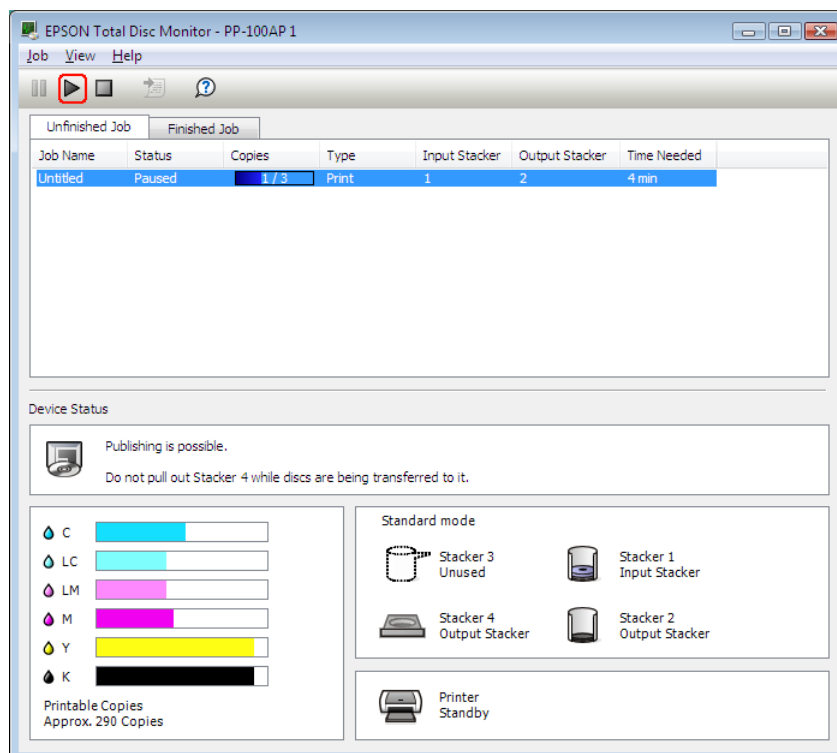

Canceling Publishing

If you need to cancel publishing, follow the instructions below.

Start EPSON Total Disc Monitor. Select the job you want to cancel in the Unfinished Job list, and then select **Cancel Job** from the Job menu or click  button.

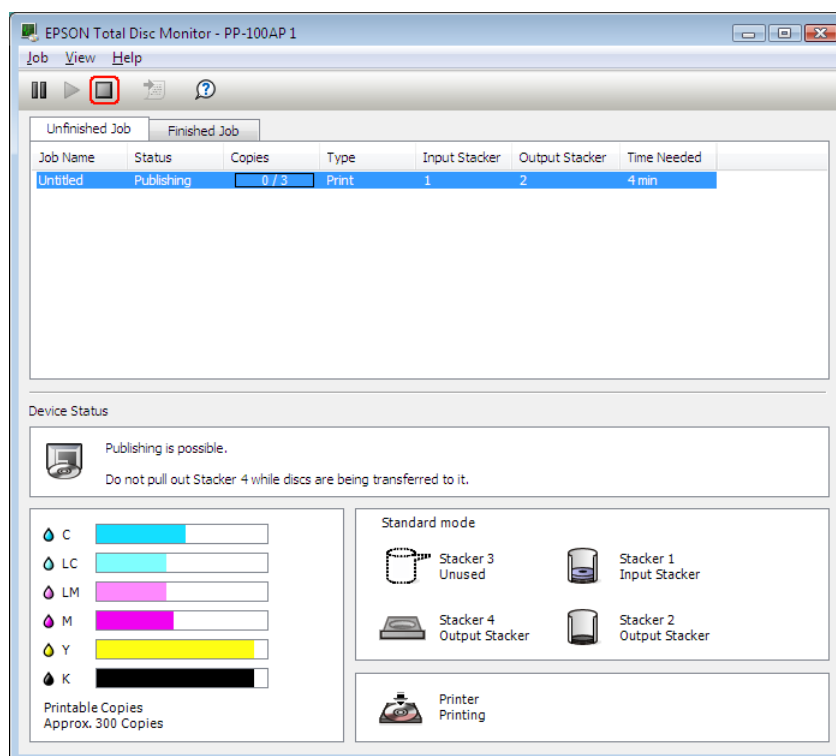

Replacing Ink Cartridges

Checking the Ink Cartridge Status

Note:

- ❑ Epson cannot guarantee the quality or reliability of non-genuine ink.
- ❑ When an ink cartridge is running low, the status is displayed on the EPSON Total Disc Monitor.

To check the ink cartridge status, do the following:

- ❑ EPSON Total Disc Monitor appears automatically when you start a job. You can check the ink cartridge status from this window. You can also run EPSON Total Disc Monitor from the Start menu.
➔ See “Using EPSON Total Disc Monitor” on page 79.

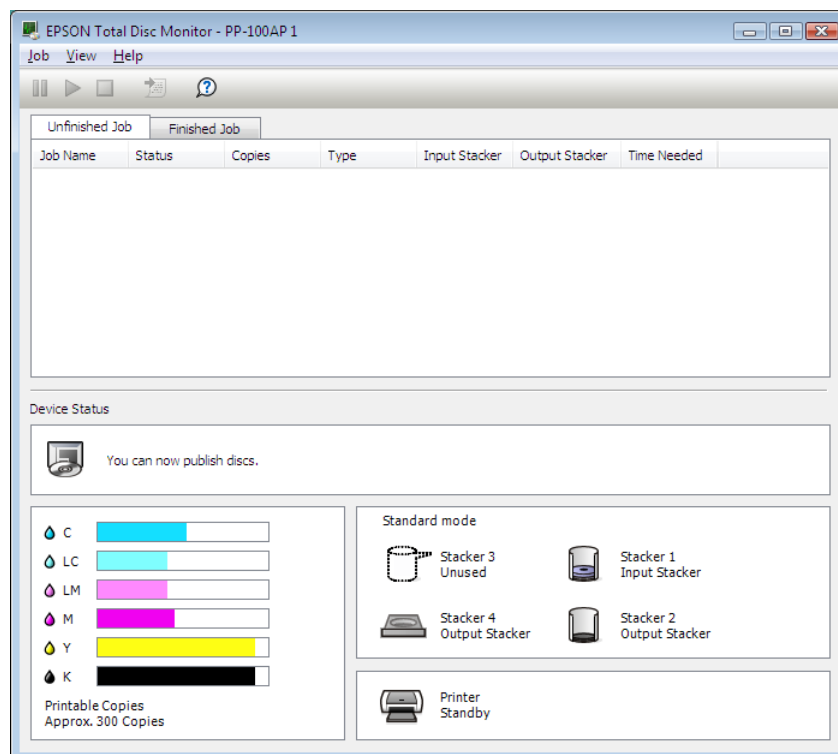

Note:

If any of the ink cartridges installed in the product is broken, incompatible with the product model, or improperly installed, EPSON Total Disc Monitor will not display an accurate calculation of the ink cartridge status. Be sure to replace or reinstall any such ink cartridge with an ink cartridge supported by the product.

Precautions on Ink Cartridge Replacement

Read all the instructions in this section before replacing the ink cartridges.

- ❑ Install all six ink cartridges. Disc publishing cannot be done even if only one ink is missing.
- ❑ This product uses ink cartridges equipped with an IC chip that monitors the amount of ink used by each cartridge. Cartridges are usable even if they are removed and reinserted. However, some ink is consumed each time cartridges are inserted, because the product automatically checks their reliability.
- ❑ The valve in the ink supply port is designed to contain any excess ink that may be released. However, careful handling is recommended. Do not touch the supply port of the ink cartridge or its surrounding area.
- ❑ Ink is consumed during the following operations: ink charging when an ink cartridge is installed, print head cleaning, and automatic cleaning executed periodically.
- ❑ For maximum ink efficiency, only remove an ink cartridge when you are ready to replace it. Ink cartridges with low ink status may not be used when reinserted.
- ❑ Do not refill the ink cartridges. Other products not manufactured by Epson may cause damage that is not covered by Epson's warranties, and under certain circumstances, may cause erratic product behavior.
- ❑ Keep ink cartridges out of the reach of children. Do not allow children to drink from or handle the cartridges.
- ❑ Be careful when you handle used ink cartridges, as there may be some ink around the ink supply port. If ink gets on your skin, wash the area thoroughly with soap and water. If ink gets into your eyes, flush them immediately with water. If discomfort or vision problems continue after a thorough flushing, see a doctor immediately.
- ❑ Epson recommends the use of genuine Epson ink cartridges. The use of non-genuine ink may cause damage that is not covered by Epson's warranties, and under certain circumstances, may cause erratic product behavior.
- ❑ Do not open the ink cartridge package until you are ready to install it in the product.
- ❑ Use ink cartridges within six months after opening the packages.
- ❑ Leave the old cartridge installed in the product until you have obtained a replacement; otherwise, ink remaining in the print head nozzles may dry out.



- ❑ You cannot continue printing with one ink cartridge after it has reached its replacement time, even if the other cartridges still contain ink. Before printing, replace the used cartridge.
- ❑ Do not turn off the product or open ink cartridge cover while loading ink (power light is flashing). Opening of covers may cause the ink to re-load, resulting in more of the ink being consumed. Also, normal printing may be disturbed.
- ❑ If the ink cartridge is not recognized even it is correctly installed, there may be dirt on the green circuit board. Remove the cartridge and wipe the circuit board with a soft cloth and install it again.
- ❑ Color adjustment of the product is based on the use of genuine ink cartridges. Use of non-genuine ink cartridges may result in reduced print quality and the product performance may not be optimum.
- ❑ When the ink lamp is flashing or lit ink cartridge is not correctly installed. Check if it is installed correctly.
- ❑ If installing ink cartridge does not provide normal printing, press cleaning button for 3 seconds. If it does not resolve the problem, repeat the process for 1 or 2 times.
- ❑ By turning off the product using the power button, print head will be automatically covered to prevent ink from drying. When not in use after installing ink cartridges, make sure to turn off using the power button. Do not unplug power cord or shut down breaker while the power is on.
- ❑ When moving or transporting product after installing ink cartridges, move or transport with ink cartridges installed.

Replacing an Ink Cartridge

Note:

- ❑ *Do not open the ink cartridge package until you are ready to install it in the product.*
- ❑ *To confirm the status of each ink cartridge, see the following section:*
- ➔ See “Using EPSON Total Disc Monitor” on page 79.

This table describes the status of the lights and the actions you need to take.



Lights	Action
	Ink is low. Obtain a replacement ink cartridge.
	The ink cartridge has reached its replacement time. Replace the used ink cartridge with a new one.

 : flashing  : on

To replace an ink cartridge, follow the steps below.

 **Caution:** Do not remove the cartridge from the product until you are ready to replace it with another.

Note:
The illustrations show replacement of the light magenta ink cartridge, but the instructions are the same for all the cartridges.

1. Make sure that the   power light is on, but not flashing.
2. Open the ink cartridge cover.

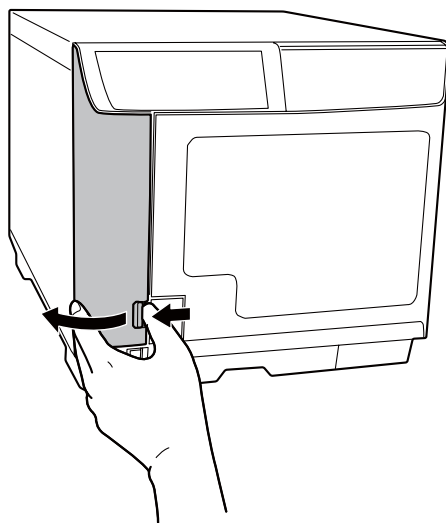

Note:
Wait for 4 seconds or more before removing the ink cartridge. Ink may squirt.

3. Push the used cartridge so the cartridge is slightly pushed out.

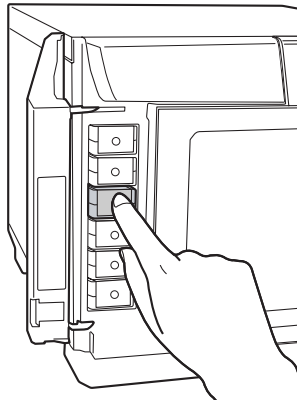

4. Carefully pull the used cartridge straight out of the slot. Dispose of it properly.

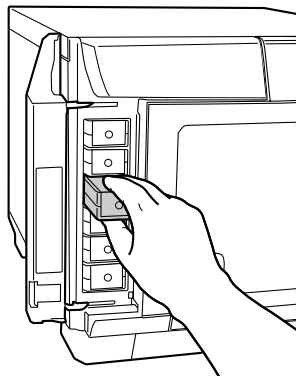

5. Remove the new ink cartridge from the package.



Caution:

- ❑ Do not touch the green IC chip on the side of the cartridge. This can damage the ink cartridge.

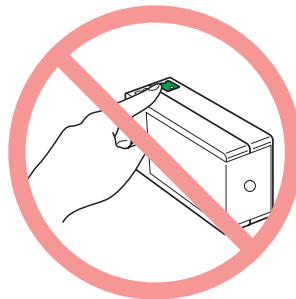

- ❑ Always install an ink cartridge immediately after removing the old cartridge. If the cartridge is not installed promptly, the print head may dry out and be unable to print.
- ❑ Do not refill the ink cartridge. Other products not manufactured by Epson may cause damage that is not covered by Epson's warranties, and under certain circumstances, may cause erratic product behavior.

6. Place the new ink cartridge into the slot. Then push the ink cartridge until it clicks into place.

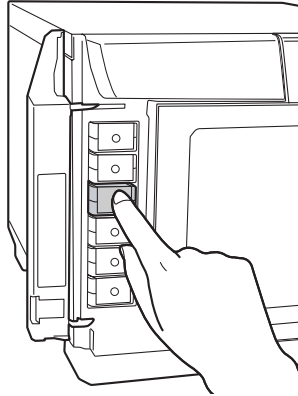

7. When you are finished replacing cartridges, close the ink cartridge cover.

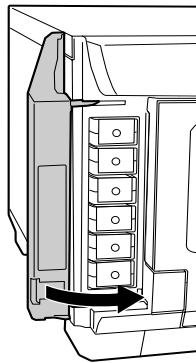

Checking the Print Head Nozzles

If you find that the printout is unexpectedly faint or that dots are missing, you may be able to identify the problem by checking the print head nozzles.

You can check the print head nozzles from your computer by using the Nozzle Check utility.

Using the Nozzle Check utility

Follow the steps below to use the Nozzle Check utility.

1. Make sure that an unprinted disc is installed in Stacker 1.
2. Make sure that no lights are indicating errors, and that the disc cover is closed.
3. Access the printer driver.

See “Accessing the printer driver” on page 17.

4. Click the **Utility** tab, then click the **Nozzle Check** button.
5. Follow the on-screen instructions.

Below are two sample nozzle check patterns.

Compare the quality of the printed check page with the sample shown below. If there are no print quality problems, such as gaps or missing segments in the test lines, the print head is fine.

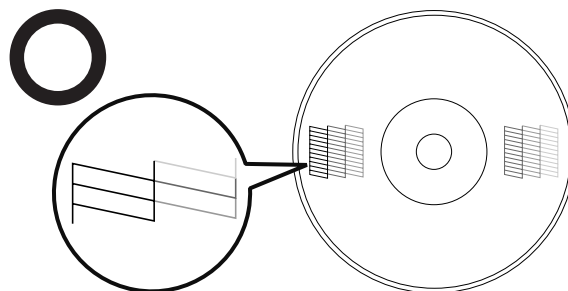

If any segment of the printed lines is missing, as shown below, this could mean a clogged ink nozzle.

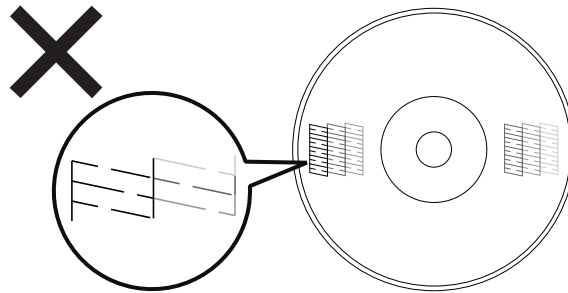

➔ See “Cleaning the Print Head” on page 65

Cleaning the Print Head

If you find that the printout is unexpectedly faint or that dots are missing, you may be able to solve these problems by cleaning the print head, which ensures that the nozzles are delivering ink properly.

You can clean the print head from your computer using the Head Cleaning utility in the printer driver or from the product by using the buttons.



Caution:

- Do not open ink cartridge cover while cleaning print head. Print head cleaning will stop if ink cartridge cover is opened.*
- Print head cleaning will consume ink. Excess print head cleaning will result in reduction of ink cartridge life.*

Note:

- Clean the print head only if print quality declines; for example, if the printout is blurry or the color is incorrect or missing.*
- Use the Nozzle Check utility first to confirm that the print head needs to be cleaned. This saves ink.*
- When ink is low you may not be able to clean the print head. When ink has reached its replacement time, you cannot clean the print head. Replace the appropriate ink cartridge first.*

Using the Head Cleaning utility

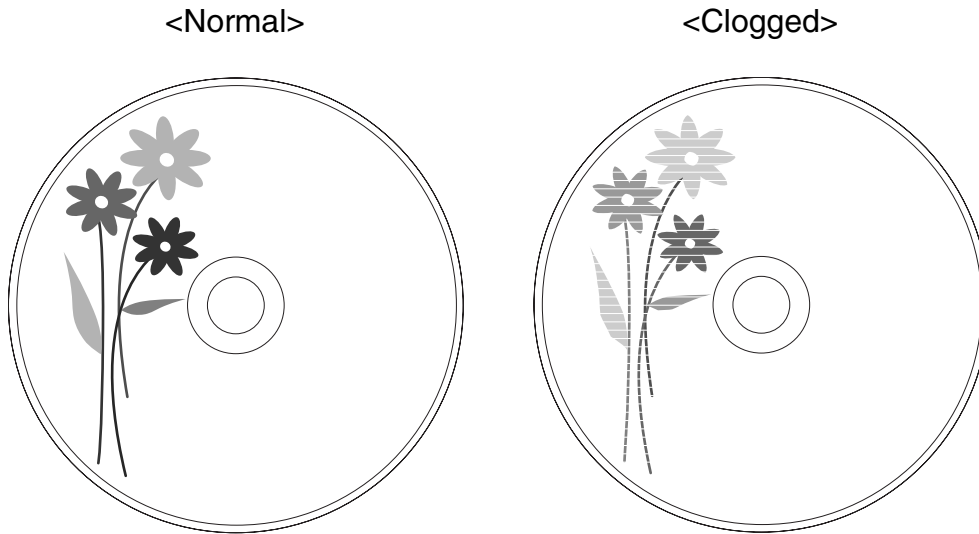

Follow the steps below to clean the print head using the Head Cleaning utility.

1. Make sure the product is turned on.
2. Make sure that no lights are indicating errors, and that the disc cover is closed.
3. Access the printer driver.

See “Accessing the printer driver” on page 17.

4. Click the **Utility** tab, then click the **Head Cleaning** button.
5. Follow the on-screen instructions.

The  power light flashes while the product performs the cleaning cycle.



Caution:

Never turn off the product while the  power light is flashing. Doing so may damage the product.

Note:

- ❑ If print quality has not improved after repeating this procedure about four times, turn the product off and wait for at least six hours. Then run the nozzle check again and repeat the head cleaning if necessary.
- ❑ If the print quality still has not improved, at least one of your ink cartridges may be old or damaged and may need to be replaced.
 - ➔ See “Replacing an Ink Cartridge” on page 60.

Using the product buttons

Follow the steps below to clean the print head using the product buttons.

1. Make sure the PC is turned on.
2. Make sure the product is turned on.
3. Make sure that no lights are indicating errors, and that the disc cover is closed.
4. Press and hold down the  Cleaning button for three seconds.

The product starts cleaning the print head and the  power light begins flashing.



Caution:

Never turn off the product while the  power light is flashing. Doing so may damage the product.

5. When the  power light stops flashing, print a nozzle check pattern to confirm that the head is clean.
➔ See “Checking the Print Head Nozzles” on page 64.

Note:

- If print quality has not improved after repeating this procedure about four times, turn the product off and wait for at least six hours. Then run the nozzle check again and repeat the head cleaning if necessary.*
- If the print quality still has not improved, at least one of your ink cartridges may be old or damaged and may need to be replaced.
➔ See “Replacing an Ink Cartridge” on page 60.*

Aligning the Print Head

If you notice a misalignment of vertical lines or horizontal banding, you may be able to solve this problem by using the Print Head Alignment utility in your printer driver.

Note:

Disc thickness may vary depending on products. Using discs with various thickness may result in misalignment of the print head. Use the Print Head Alignment utility to check and adjust the print head alignment. It is recommended to use the same product and type of discs when publishing several discs.

Using the Print Head Alignment utility

Follow the steps below to align the print head using the Print Head Alignment utility.

1. Make sure that an unprinted disc is inserted in Stacker 1.
2. Make sure that no lights are indicating errors, and that the disc cover is closed.
3. Access the printer driver.

See “Accessing the printer driver” on page 17.

4. Click the **Utility** tab, then click the **Print Head Alignment** button.
5. Follow the on-screen instructions to align the print head.



Caution:

- By entering value at confirmation screen after initial adjustment, adjustment will be done using the initial value and entered value added together. To clear adjustment value, select Reset and click Exit.*
- If the label printing surface is not aligned with center of the disc after aligning the print head as described above, print will appear out of alignment compared to printing surface.*

Correcting the Printing Position

If you notice a misalignment of vertical printing position, you may be able to solve this problem by using the Correcting the Printing Position utility in your printer driver.

Using the Correcting the Printing Position utility

Follow the steps below to adjust the vertical and horizontal printing position using the Correcting the Printing Position utility.

1. Make sure that a dummy disc or blank is inserted in Stacker 1.
2. Make sure that no lights are indicating errors, and that the disc cover is closed.
3. Access the printer driver.

See “Accessing the printer driver” on page 17.

4. Click the **Utility** tab, then click the **Correcting the Printing Position** button.
5. Follow the on-screen instructions to adjust the vertical and horizontal printing position.

Cleaning Your Product

Cleaning the exterior of the product

To keep your product operating at its best, clean it thoroughly several times a year by using the following procedure.



Caution:

- ❑ *Never use alcohol or thinner to clean the product. These chemicals can damage the product.*
 - ❑ *Take care to prevent water from getting inside the product. If moisture, dirt, or other matter gets inside of the product, besides affecting print quality, it may cause the electric circuits to short.*
1. Make sure the product is turned off and all the lights are off, and then unplug the power cord from the electrical outlet.
 2. Use a soft, clean cloth to carefully remove any dust or dirt.

If the dirt does not come off, clean it using a soft, clean cloth dampened with a mild detergent. Then, wipe the outside of the product dry with a dry, soft cloth.

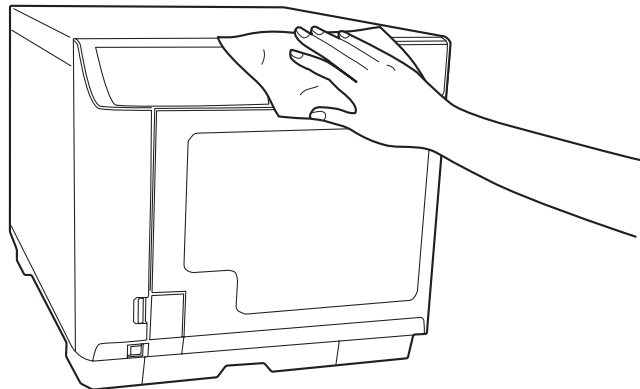

Note:

After cleaning the product, close the disc cover and the Stacker 4 tray to protect the product from dust.

Cleaning the interior of the product

To keep your printouts at their best, clean the inside by using the following procedure.

1. Make sure the product is turned off and all the lights are off, and then unplug the power cord from the electrical outlet.
2. Open the disc cover, and remove the stackers from the product.
3. Use a soft, clean cloth to carefully remove any dust or dirt from the stackers and inside of the product.
4. Place the stackers back in the position.



Caution:

- Be careful to keep water away from the electronic components.*
- Do not spray the inside of the product with lubricants.*
- Dirt attached to Stacker 3 or 4 should be wiped clean with a soft cloth moistened with neutral detergent.*

Getting Maintenance Information

You can get helpful information for maintenance and support of the product, cumulative number of published discs and free space of the maintenance box.

1. Make sure that the product is connected to the computer via the USB cable and that the product is turned on.

2. Access the printer driver.

See “Accessing the printer driver” on page 17.

3. Click the **Maintenance Info** tab.

Replacing the Maintenance Box

The maintenance box absorbs ink wasted during printing and head cleaning. When the maintenance box becomes full, the product stops publishing discs.

Note:

- ❑ You can check the free space of the maintenance box on the printer driver.
➔ See “Getting Maintenance Information” on page 70.
- ❑ When it is almost time to replace the maintenance box, a message notifying you that it is almost time to replace it is displayed once per day when you start up EPSON Total Disc Monitor.
- ❑ When it is time to replace the maintenance box, all the ink lamps flash rapidly and a message notifying you that it is time to replace it is displayed on EPSON Total Disc Monitor.

See the instruction manual of the maintenance box for replacing the maintenance box. Be sure to replace also the filter when you replace the maintenance box.

**Caution:**

- ❑ When it is time to replace the maintenance box, job processing automatically stops. You can replace the maintenance box without turning the power off, and then resume job processing. However, do not move the product or subject it to any impact while processing a job.
- ❑ Epson recommends the use of genuine Epson maintenance boxes. The use of non-genuine maintenance boxes may cause damage that is not covered by Epson's warranties, and under certain circumstances, may cause erratic product behavior.
- ❑ Do not use any maintenance box removed from the product and left for a long period.
- ❑ Do not tilt the used maintenance box. Otherwise ink may leak.
- ❑ Do not touch the green IC chip on the maintenance box.
- ❑ Do not touch the ink ejection port of the maintenance box or the inside of the box insertion opening of the product.
- ❑ Be careful not to touch the ink on the maintenance box cover and filter cover.
- ❑ Do not take out/put in the maintenance box more than necessary. Otherwise some parts of the ink pad may drop inside the product.

Transporting Your Product

If you need to transport your product some distance, carefully prepare and repack it. Be sure to use the original box and packing materials.

**Warning:**

The product is heavy, so have two people lift the product.

**Caution:**

- ❑ *When storing or transporting the product, do not tilt it, stand it up vertically, or turn it upside down. If you need to transport the product, carefully prepare and repack it using the original box and packing materials in order to protect the product from shock.*
- ❑ *Leave the ink cartridges installed. Removing the cartridges can dry out the print head and may prevent the product from printing.*
- ❑ *Leave the maintenance box installed. Removing the maintenance box may cause ink leakage.*

1. Turn off the product and unplug its power cord.
2. Disconnect the interface cable.
3. Remove all discs from the stackers.
4. Open the ink cartridge cover. Secure the ink cartridges with tape, then close the ink cartridge cover.
5. Close the disc cover and Stacker 4 tray. Secure them with tape.
6. Attach the protective materials to both sides of the product.
7. Repack the product and accessories in the original box.

Note:

- ❑ *Keep the product level during transport.*
- ❑ *Be sure to remove the protective materials and tape from the product before using it again.*
- ❑ *Be sure to lift the product by the correct positions, as shown below.*

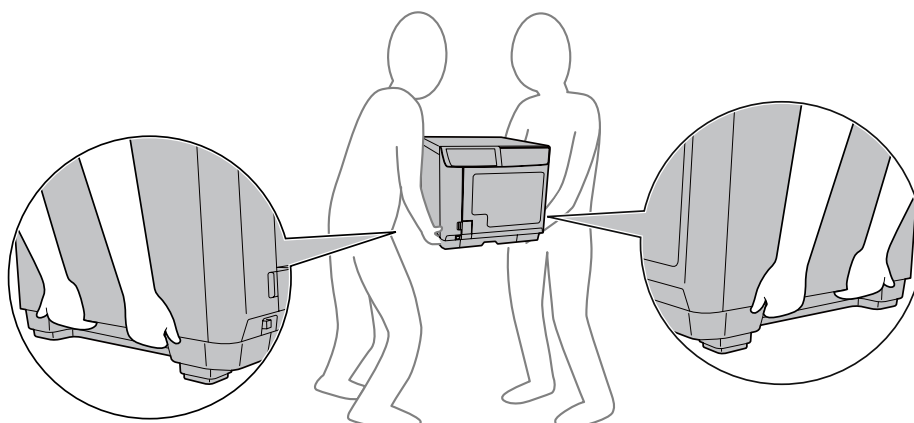

Diagnosing the Problem

Troubleshooting product problems is best handled in two steps: first diagnose the problem, then apply likely solutions until the problem is fixed.

The information that you need to diagnose and solve most common problems is provided by Help, the control panel, and the EPSON Total Disc Monitor utility. Refer to the appropriate section below.

If you have a specific problem relating to publishing quality, a problem not related to publishing quality, or a disc feeding problem, or if the product does not publish at all, refer to the appropriate section.

To solve a problem, you may need to cancel publishing.

➔ See “Canceling Publishing” on page 57.

Error indicators

You can identify many common problems using the lights on your product. If the product stops working and the lights are on or flashing, use the following table to diagnose the problem; then follow the recommended corrective measures.

Note:

Condition of indicator lights after error may change depending on the operation.

● : on, ○ : off, ◉ : flashing, ● : flashing fast

Error associated with cover

Lights								Conditions/Remedies
Power	Busy	Error	Ink	Stacker				
				1	2	3	4	
●	○	●	○	○	○	○	○	<p>Disc cover or ink cartridge cover open Close covers.</p> <p>Job is paused since disc cover or ink cartridge cover was opened while processing the job Wait for the job to resume.</p>

Error associated with disc transfer

Lights								Conditions/Remedies
Power	Busy	Error	Ink	Stacker				
				1	2	3	4	
●	○	●	○	○	○	○	○	<p>Disc pick up error Resolve the problem as follows.</p> <ol style="list-style-type: none"> 1. Open the disc cover and fan the discs inside the input stacker. 2. Close the disc cover and publish disc again. <p>If the same error occurs frequently, contact your dealer.</p> <p>Multiple feed error Resolve the problem as follows.</p> <ol style="list-style-type: none"> 1. Open the disc cover. 2. Remove the discs from the printer tray. 3. Fan the discs inside the input stacker to avoid disc sticking. 4. Insert other discs into the input stacker. 5. Close the disc cover and publish disc again. <p>If the same error occurs frequently, contact your dealer.</p>

Lights								Conditions/Remedies
Power	Busy	Error	Ink	Stacker				
				1	2	3	4	
●	○	●	○	○	○	○	○	<p>Disc transfer error Turn off the product and remove the disc. If the same error occurs frequently, contact your dealer.</p> <p>Arm failed to release disc Turn off the product and remove disc. Do not remove disc from the arm by hand if arm is picking up the disc. This may damage the arm. To remove the disc from the arm, turn on the product again and let initializing process remove the disc. If the same error occurs frequently, contact your dealer.</p> <p>Internal error Turn off the product and check inside for any objects, then turn on the product again. If the same error occurs frequently, contact your dealer. Do not remove disc from the arm by hand if arm is picking up the disc. This may damage the arm. To remove the disc from the arm, turn on the product again and let initializing process remove the disc.</p>

Error associated with stacker

Lights								Conditions/Remedies
Power	Busy	Error	Ink	Stacker				
				1	2	3	4	
●	○	●	○	○	○	●	○	<p>Stacker 3 is inserted for Standard Mode or External Output Mode Remove Stacker 3.</p>
●	○	●	○	●	○	○	○	<p>Stacker 1 is not correctly inserted Make sure that Stacker 1 is correctly inserted.</p>
●	○	●	○	○	●	○	○	<p>Stacker 2 is not correctly inserted Make sure that Stacker 2 is correctly inserted.</p>

Lights								Conditions/Remedies
Power	Busy	Error	Ink	Stacker				
				1	2	3	4	
●	○	●	○	○	○	●	○	Stacker 3 is not correctly inserted for Batch Mode Make sure that Stacker 3 is correctly inserted.
●	○	○	○	●	○	○	○	Stacker 1 is empty Load discs into Stacker 1. Note: <i>The stacker lamp flashes when the source stacker is out of discs; however, the timing of the light flashing may not match with the timing of the stacker becoming empty.</i>
●	○	○	○	○	●	○	○	Stacker 2 is empty Load discs into Stacker 2. Note: <i>The stacker lamp flashes when the source stacker is out of discs; however, the timing of the light flashing may not match with the timing of the stacker becoming empty.</i>
●	○	●	○	●	○	○	○	Stacker 1 is overloaded Remove discs so that discs are below the red line.
●	○	●	○	○	●	○	○	Stacker 2 is overloaded Remove discs so that discs are below the red line.
●	○	●	○	○	○	●	○	Stacker 3 is overloaded Remove all the discs from Stacker 3.
●	○	○	○	○	●	○	○	Stacker 2 is full Remove published discs from Stacker 2.
●	○	○	○	○	○	●	○	Stacker 3 is full Remove published discs from Stacker 3.
●	○	●	○	○	○	○	●	Stacker 4 is full Remove published discs from Stacker 4.
●	○	○	○	○	○	○	●	Stacker 4 is open Close Stacker 4.

Error associated with ink

Lights								Conditions/Remedies
Power	Busy	Error	Ink	Stacker				
				1	2	3	4	
●	○	○	○	○	○	○	○	<p>Ink low</p> <p>Obtain a replacement ink cartridge. To determine which cartridge is low, check the ink cartridge status. See "Checking the Ink Cartridge Status" on page 58.</p>
●	○	○	●	○	○	○	○	<p>The ink has reached its replacement time or it is not installed correctly.</p> <p>Replace the ink cartridge or reinstall it.</p> <p>If the ink cartridge is not recognized even if it is installed correctly, there may be dirt on the green circuit board. Wipe it with soft cloth and install it again.</p> <p>The product will stop operation before ink is completely empty in order to maintain print head quality. Therefore, some ink will be left in the ink cartridge.</p> <p>It is recommended to use a genuine ink cartridge.</p>
●	○	○	●	○	○	○	○	<p>Ink cartridge not fully inserted</p> <p>All ink lights are on.</p> <p>Check ink cartridges and make sure they are all fully inserted.</p>

Error associated with product

Lights								Conditions/Remedies
Power	Busy	Error	Ink	Stacker				
				1	2	3	4	
○	○	○	●	○	○	○	○	<p>The maintenance box has reached its replacement time or it is not installed correctly.</p> <p>Replace the maintenance box or reinstall it.</p> <p>If the maintenance box is not recognized even if it is installed correctly, there may be dirt on the green circuit board. Wipe it with soft cloth and install it again.</p>

Lights								Conditions/Remedies
Power	Busy	Error	Ink	Stacker				
				1	2	3	4	
●	●	●	●	●	●	●	●	Product maintenance error A product maintenance error has occurred. Turn off the product and contact your dealer.
○	○	○	○	○	○	○	○	Internal error Turn off the product and check inside for any objects. If the same error occurs frequently, contact your dealer. <ul style="list-style-type: none"> <input type="checkbox"/> Leaving the product off after the error may result in clogging of print head. Make sure to turn on the product immediately after turned off. <input type="checkbox"/> If resuming label printing after the error, run Nozzle Check and confirm the condition of the print head. <input type="checkbox"/> If the publishing does not start, check if a print job remains in the print spooler and delete all print jobs.

Other error

Lights								Conditions/Remedies
Power	Busy	Error	Ink	Stacker				
				1	2	3	4	
○	○	○	○	○	○	○	○	Improper status error Turn the product off and on. If the same error occurs frequently, contact your dealer.

EPSON Total Disc Monitor

If a problem occurs while publishing, an error message will appear in the EPSON Total Disc Monitor window.

Checking Product Status

Using EPSON Total Disc Monitor

EPSON Total Disc Monitor displays detailed information on the product status.

There are three ways to access EPSON Total Disc Monitor:

- ❑ When you send a job to the product, EPSON Total Disc Monitor appears.
- ❑ In the EPSON Total Disc Maker window, click the **Publish** button. From the Tool menu, select **Start Total Disc Monitor**.
- ❑ Click **Start** ( in Windows 7 or Windows Vista), point to **All Programs** (Windows 7, Windows Vista or Windows XP) or **Programs** (Windows 2000), point to **EPSON Total Disc Maker**, and then click **EPSON Total Disc Monitor**.

When you access EPSON Total Disc Monitor, the following window appears:

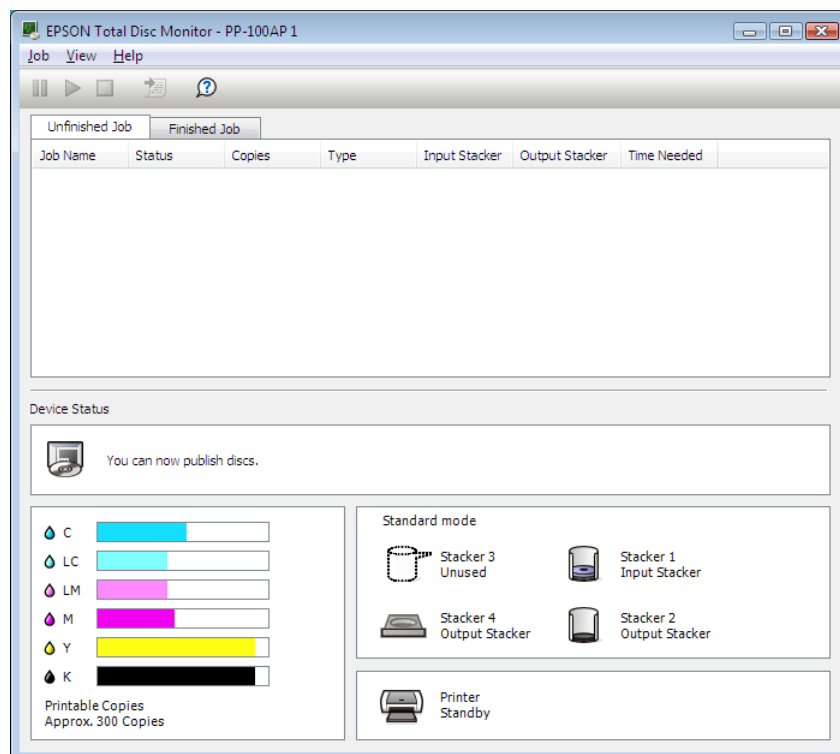

EPSON Total Disc Monitor provides the following information:

Job list:

You can check a list of jobs (up to 1000 for Unfinished Job and 50 for Finished Job) and its information, and also you can cancel, pause, and restart unfinished jobs.

Device Status:

This provides device status information. It also displays error messages as well as helpful tips for better publishing.

Ink Cartridge Status:

This provides a graphic display of the ink cartridge status.

Note:

Printable copies is an approximate value based on the number of labels that can be printed from now when printing the same label as last time. This value may differ from the actual value as a result of influences such as the printing data and printing environment. Up to 1000 is indicated as "1000 or more discs," and less than 1000 is indicated in increments of 10.

Printer, Stacker Status:

This provides a graphic display of the printer and stacker status. It also shows where an error occurs.

Disc Does Not Feed Correctly

Disc does not feed

Remove the stack of discs and make sure of the following:

- The disc is not damaged.
- The disc is not too old. See the instructions that came with the disc for more information.
- The discs are not loaded above the red line on the stacker.
- Discs may have stuck together because of incorrect transportation of the discs; therefore, discs should be separated thoroughly before loading into the stacker. Also, storing discs in the stacker for an extended period of time may cause discs to stick to each other again. If discs are stored in the stacker for an extended period of time, separate the discs again before operating the product.
- A disc is not jammed inside the product. If it is, remove the jammed disc.
➔ See "Disc jams" on page 82.

- ❑ The ink cartridges have not reached replacement time. If a cartridge has reached its replacement time, replace it.
 - ➔ See “Replacing an Ink Cartridge” on page 60.

If disc does not feed from the input stacker.

1. Open the disc cover.
2. Remove blank discs from the stacker.
3. Fan a stack of discs to prevent them from sticking together.
4. Insert discs back in the stacker.
5. Close the disc cover.
6. Publish disc again.

If disc does not feed from the printer tray.

1. Turn the power off.
2. Turn the power back on.
3. Publish disc again.

If arm has picked up disc.

Do not remove the disc by hand as arm may be damaged. To remove the disc, turn off the power and turn on the power again, and let the initializing process remove the disc.

If the same error continues to occur, contact your dealer.

Multiple discs feed

- ❑ Make sure the discs are not loaded above the red line on the stacker.
- ❑ Make sure none of the discs are damaged.
- ❑ Remove the stack of discs and make sure that the discs are not too thin.
 - ➔ See “Discs” on page 96.
- ❑ Remove discs from the stacker and fan them before loading them back.
- ❑ If only one disc is found when multiple feed error is displayed, disc thickness or warpage maybe out of standard. Follow the steps below to resolve multiple disc feed error and replace discs. If the same error continues to occur, contact your dealer.
 1. Open disc cover.
 2. Remove the disc from the tray.
 3. Remove discs from the input stacker.
 4. Insert other discs into the input stacker.
 5. Close the disc cover and the job will resume.

Disc jams

If a disc is left in the printer tray, it will be ejected when you turn off/on the product. If you cannot remove the disc by restarting the product, follow the procedures below:

1. Turn off the product and unplug the power cable from the wall outlet.
2. Open the maintenance box cover and pull out the maintenance box.



Caution:

- ❑ Do not tilt the used maintenance box. Otherwise ink may leak.
- ❑ Do not touch the ink ejection port of the maintenance box or the inside of the box insertion opening of the product.

3. Push the printer tray.

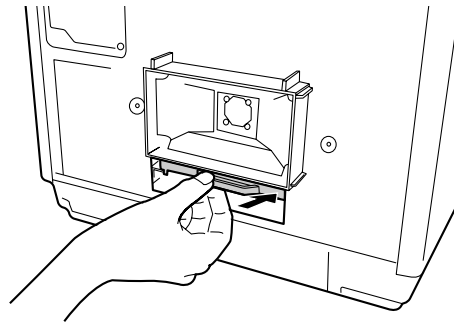

4. Open the disc cover, remove all the discs inside, and then close the disc cover.
5. Reinstall the maintenance box and close the maintenance box cover.
6. Plug the power cable to the wall outlet and turn on the product.
The printer tray automatically closes.

Note:

- ❑ If you cannot easily remove a foreign object, do not use force and do not disassemble the product. Call your dealer for assistance.
- ❑ If arm is stopped while picking up disc, do not try removing disc by hand. This may result in damaging the arm. If such an error occurs, turn off/on the power and try resolving the problem by initializing the product. If the error continues to occur, contact customer support.



If your discs jam frequently, make sure of the following:

- ❑ The discs are smooth, not damaged.
- ❑ You are using a high-quality discs.
- ❑ The printable side of the discs are face up in the stacker.
- ❑ The stack of discs was fanned before loading.
- ❑ The stack of discs is not loaded above the red line on the stacker.

- ❑ The number of discs in the stacker does not exceed the limit specified for that disc.
➔ See “Mechanical” on page 102.
- ❑ The product is on a flat, stable surface that extends beyond the base in all directions.
The product will not operate properly if it is tilted.

Print Quality Problems

If you are having a print quality problem, then compare it with the illustrations below. Click the caption under the illustration that best resembles your printout.

<p>enthalten alle i Aufdruck. W J 5008 "Regel</p> <p>Good sample</p>	 <p>Good sample</p>
<p>enthalten alle i Aufdruck. W J 5008 "Regel</p> <p>"Horizontal banding" on page 85</p>	<p>enthalten alle i Aufdruck. W J 5008 "Regel</p> <p>"Vertical misalignment" on page 85</p>
 <p>"Horizontal banding" on page 85</p>	 <p>"Vertical misalignment" on page 85</p>



"Incorrect or missing colors" on
page 86



"Blurry or smeared printout" on
page 86

Horizontal banding

- ❑ Make sure the printable side of the disc is face up in the Stacker.
- ❑ Run the Head Cleaning utility to clear any clogged ink nozzles.
➔ See “Cleaning the Print Head” on page 65.
- ❑ Use ink cartridges within six months after opening the packages.
- ❑ Use genuine Epson ink cartridges.
- ❑ Check the Δ ink light. If the light is on, replace the appropriate ink cartridge.
➔ See “Replacing an Ink Cartridge” on page 60.
- ❑ Make sure the label type selected in the printer driver is appropriate for the type of disc loaded in the product.
➔ See “Publishing Discs” on page 20.

Vertical misalignment

- ❑ Run the Print Head Alignment utility.
➔ See “Aligning the Print Head” on page 67.
- ❑ Make sure the label type selected in the printer driver is appropriate for the type of disc loaded in the product.
➔ See “Publishing Discs” on page 20.

Banding

- ❑ Make sure the printable side of the disc is face up in the Stacker.
- ❑ Run the Head Cleaning utility to clear any clogged ink nozzles.
➔ See “Cleaning the Print Head” on page 65.
- ❑ Make sure the label type selected in the printer driver is appropriate for the type of disc loaded in the product.
➔ See “Publishing Discs” on page 20.
- ❑ Due to the variation in the quality of discs, print results using the same type of discs from the same data may not be the same.

Incorrect or missing colors

- ❑ Adjust the color settings in your application or in your printer driver settings. Check the Main window.
See the printer driver online Help for details.
- ❑ Run the Head Cleaning utility.
➔ See “Cleaning the Print Head” on page 65.
- ❑ Check the \triangle ink light. If the light is on, replace the appropriate ink cartridge.
➔ See “Replacing an Ink Cartridge” on page 60.
- ❑ If you have just replaced an ink cartridge, make sure the date on the box has not expired. If you have not used the product for a long time, replace the ink cartridges.
➔ See “Replacing an Ink Cartridge” on page 60.

Blurry or smeared printout

- ❑ Use genuine Epson ink cartridges.
- ❑ Make sure the product is on a flat, stable surface that extends beyond the base in all directions. The product will not operate properly if it is tilted.
- ❑ Make sure your disc is not damaged, dirty, or too old.
- ❑ Make sure your disc is dry and the printable side is facing up.
- ❑ Make sure the label type selected in the printer driver is appropriate for the type of disc loaded in the product.
➔ See “Publishing Discs” on page 20.
- ❑ Do not touch or allow anything to come into contact with the printed side of disc with a shiny finish. After printing on a glossy disc, allow the ink to set for a few hours before handling it.
- ❑ Run the Head Cleaning utility.
➔ See “Cleaning the Print Head” on page 65.

Miscellaneous Printout Problems

Incorrect or garbled characters

- ❑ Clear any stalled print jobs from the Windows Spooler.
- ❑ Turn off the product and computer. Make sure the product's interface cable is securely plugged in.
- ❑ Uninstall the printer driver, then reinstall it.
 - ➔ See "Uninstalling Software" on page 19.

Incorrect margins

- ❑ Check the Inner/Outer Diameter settings in your application. Make sure that the margins are within the printable area of the disc.
 - ➔ See "Printable area" on page 99.
- ❑ Make sure the printer driver settings are appropriate for the label size you are using. Check the Main window. See the printer driver online Help for details.
- ❑ Uninstall the printer driver, then reinstall it.
 - ➔ See "Uninstalling Software" on page 19.
- ❑ The printing location may shift depending on the disc used. Perform Print Head Alignment or Correcting the Printing Position.
 - ➔ See "Correcting the Printing Position" on page 68.
- ❑ The ink receptor layer may shift from the center of the disc making the print location to appear shifted from the ink receptor layer. Check if the ink receptor layer is shifted from the center of the disc or from the outer edge.

Printout has a slight slant

- ❑ Perform Nozzle Check, Print Head Cleaning, and Print Head Alignment utilities.

Printed side is smeared or scuffed

- ❑ Select the appropriate disc size setting in the printer driver.
- ❑ Uninstall the printer driver, then reinstall it.
 - ➔ See “Uninstalling Software” on page 19.

Printing is too slow

- ❑ Make sure the label type selected in the printer driver is appropriate for the type of disc loaded in the product.
 - ➔ See “Publishing Discs” on page 20.
- ❑ Close any unnecessary applications.
- ❑ Make sure that printing mode is set to bi-directional.
- ❑ If you print continuously for an extended period, the disc may temporarily stop feeding or the printing may pause for a while. This is to slow down the printing speed and prevent the product mechanism from overheating and being damaged. If this happens, you can continue to print, but we recommend stopping and leaving the product for about thirty minutes with the power on. (The product will recover after about 3 hours with the power off.) After you restart, the product will print at normal speed.
- ❑ Uninstall the printer driver, then reinstall it.
 - ➔ See “Uninstalling Software” on page 19.

Ink adheres to the recording surface

- ❑ Depending on the type of disc, ink may adhere to the recording surfaces if they are stacked right after printing. Make sure of the type of disc before using.
- ❑ Keep the printing surface of the disc away from other discs until ink of the printed disc is completely dry, otherwise marks or smudges may be left at contact area.

The Product Does Not Function

All lights are off

- ❑ Press the ⏻ power button to make sure the product is on.
- ❑ Turn off the product, and make sure that the power cord is securely plugged in.
- ❑ Make sure that your outlet works and is not controlled by a wall switch or timer.

Lights came on and then went out

The product's voltage may not match the outlet rating. Turn off the product and unplug it immediately. Then check the label on the back of the product.



Caution:

If the voltage does not match, DO NOT PLUG YOUR PRODUCT BACK IN. Contact your dealer.

Only the power light is on

- ❑ If you press the ⏻ power button lightly, the product may not turn on, although the ○ ⏻ power light flashes for a while. Press the button firmly.
- ❑ Turn off the product and computer. Make sure the product's interface cable is securely plugged in.
- ❑ If you are trying to print a large image, your computer may not have enough memory. Try reducing the resolution of your image or printing the image at a smaller size. You may need to install more memory in your computer.
- ❑ Uninstall the printer driver, then reinstall it.
 - ➔ See "Uninstalling Software" on page 19.

The ink light is flashing or is on after you replace the cartridge

Make sure the ink cartridge is correctly installed.

Software cannot be installed

- ❑ Is the USB cable unplugged? Make sure that the USB cable is firmly connected.
- ❑ Does the USB cable match the computer and the product requirements? The USB cable used to connect the computer and the product should be USB 2.0 compatible.
- ❑ Has the HDD sufficient free space? The software cannot be installed if the HDD does not have free space of more than 10GB.
- ❑ Did you log on as a user with administrator privileges (belonging to the administrator group) for Windows? When installing the software, log on as a user with administrator privileges (belonging to the administrator group).
- ❑ Are you using a USB hub? The USB cable should be connected directly between the PC and the product.
- ❑ Is Windows Media Player installed? Windows Media Player must be installed before installing the Total Disc Maker.
- ❑ The output device may not be recognized in the environment with Windows Media Player 7 installed. In this case, uninstall the EPSON Total Disc Maker and restart the computer, then reinstall the EPSON Total Disc Maker.
- ❑ If the language setting of the system and the user is different, installation may not be correctly performed. Make sure to set the language setting of the system and the user to the same before installation.

When installing the software, make sure to turn the product off; then start installation.

Maintenance Box Nearly Full message is displayed by the software

The maintenance box is nearly full.

➔ See “Replacing the Maintenance Box” on page 70.

Disc cannot be published

If the user is logged on as a guest and could not access the service, terminal service must be enabled before publishing (except for Windows 7 or Windows Vista). Contact administrator for terminal service settings.

Where To Get Help

Contacting Customer Support

Before Contacting Epson

If your Epson product is not operating properly and you cannot solve the problem using the troubleshooting information in your product documentation, contact customer support services for assistance. If customer support for your area is not listed below, contact the dealer where you purchased your product.

Customer support will be able to help you much more quickly if you give them the following information:

- Product serial number
(The serial number label is usually on the back of the product.)
- Product model
- Product software version
(Click **About**, **Version Info**, or similar button in the product software.)
- Brand and model of your computer
- Your computer operating system name and version
- Names and versions of the software applications you normally use with your product

Help for Users in the United States and Canada

Contacts for information, support, and services are:

Discproducer Technical Support: 562-276-1360

Location: Epson America Inc.

Web site URL: <http://www.discproducer.epson.com>

This site will provide the end user with access to the latest drivers and FAQs.

Help for Users in the Europe (EMEA)

Contacts for information, support, and services are:

Web site URL: <http://www.epson-europe.com>

Or contact your local distributor or Epson sales company.

If you need the latest drivers, FAQs, manuals, or other downloadable, access the site at:

<http://download.epson-discproducer.com>

Product Information

Product Parts and Control Panel Functions

Product Parts

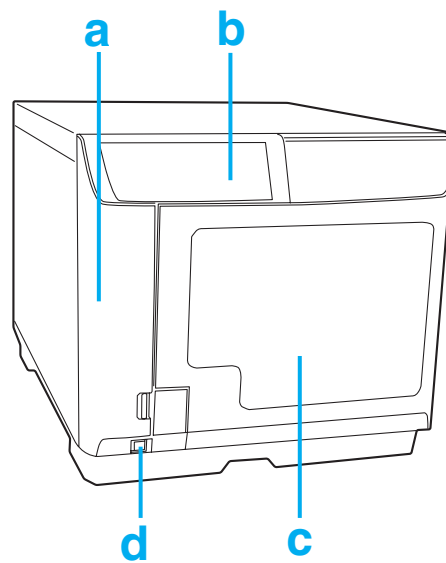

- a. Ink cartridge cover: Secures the ink cartridges. Open only when installing or replacing ink cartridges.
- b. Control Panel: Use the button and monitor the lights to control your product. See the next section for details.
- c. Disc cover: Open when loading or taking out the discs.
- d. Power button: Turns the product on or off.

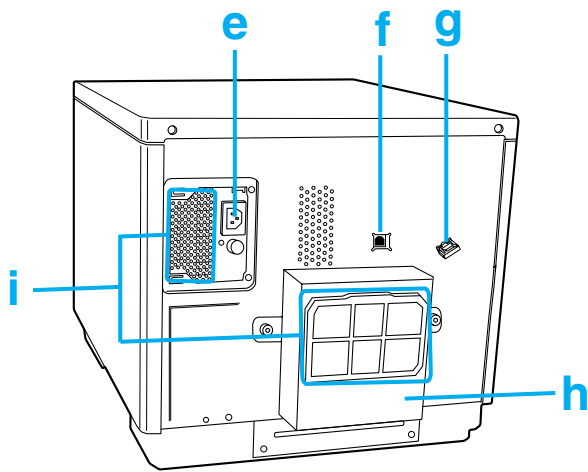

- e. AC inlet: Plug in the power cord.
- f. USB connector: Connects a USB cable from your computer to the product.
- g. Interface cable locking saddle: Use this for directing and gathering the cable.
- h. Maintenance box cover: Open this cover when replacing a maintenance box or removing a disc stuck in the printer tray.
- i. Air Vent: Leave at least 10 cm (3.94") between the back of the product and the wall for ventilation.

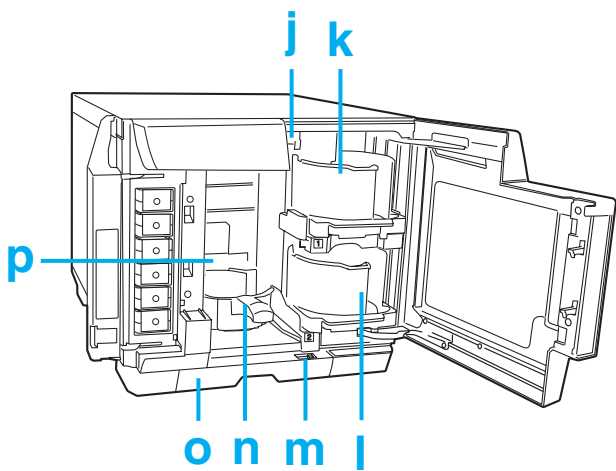

- j. Arm: Transports discs.
- k. Stacker 1: Use Stacker 1 as a disc input stacker. Holds up to 50 discs.
- l. Stacker 2: Use Stacker 2 as a disc input or output stacker. Holds up to about 50 discs.
- m. Lock lever: Use this lever to lock or unlock Stacker 4. Lock the lever when you use Stacker 3 in Batch mode.
- n. Stacker 3: Use Stacker 3 as a disc output stacker. Holds up to about 50 discs.
- o. Stacker 4: Use Stacker 4 as a disc output stacker. Holds up to about 5 discs.
- p. Printer: Prints on label surface of discs.

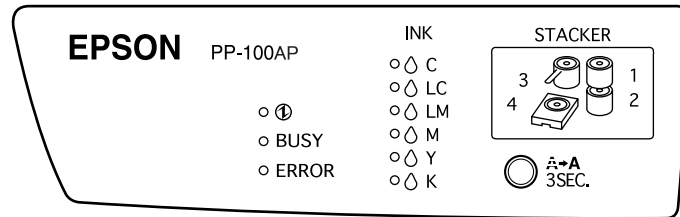

Control Panel



Buttons

Button	Function
 cleaning	Press and hold for 3 seconds to clean the print head.

Lights

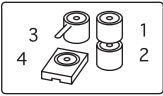
Light	Description
 power	On when the product is on. Flashes when the product is initializing, after replacing an ink cartridge, charging ink, or cleaning the print head.
BUSY	Flashes when jobs are processed.
ERROR	On when cover is open, or when disc transfer, stacker, or printer errors occur. Flashes when trouble occurs on product.
 INK	On when an ink cartridge has reached its replacement time or is not correctly inserted. Flashes when ink is low. Flashes rapidly when the maintenance box has reached its replacement time or is not correctly inserted.
 STACKER	On when the stacker is overloaded with discs, or when Stacker 3 is not removed for the Standard and External Output mode. Flashes when the stacker is not installed correctly or the stacker is out of discs. When the Stacker 4 light flashes rapidly, do not pull out Stacker 4.

For details on error status, see the following instructions.

➔ See page 73.

Consumables

Ink cartridges and Maintenance box

You can use the following ink cartridges and maintenance box with this product:

Part		Part numbers
Ink cartridge	Cyan	C13S020447
	Light Cyan	C13S020448
	Light Magenta	C13S020449
	Magenta	C13S020450
	Yellow	C13S020451
	Black	C13S020452
Maintenance box		PJMB100

To purchase a PP-100 Series exclusive ink cartridge and maintenance box, check with the dealer where you purchased your PP-100AP or access either of the following URLs:

<http://www.epson-europe.com> (Europe)

<http://www.discproducer.epson.com> (United States and Canada)

Discs

Epson offers the specified CD-R and DVD-R discs for all your printing needs.

Technical Specifications

Disc

**Caution:**

Printable disc is 12 cm (4.72") CD/DVD disc. 80 mm (3.15") disc is not supported.

Note:

- Since the quality of any particular brand or type of disc may be changed by the manufacturer at any time, Epson cannot attest to the quality of any brand or type of disc. Always test samples of disc stock before purchasing large quantities or printing large jobs.
- Poor quality disc may reduce print quality and cause disc jams or other problems. If you encounter problems, switch to a higher grade of disc.
- The specified disc is for ink jet printers. Thermal transfer discs are not supported.
- The specified disc has a moisture adhesive ink receptor layer on the label surface. If stored stacked, especially under high humidity and high temperature conditions, discs may adhere to each other. If an automatic duplication machine is used, please check the disc before using.
- Please treat the recording surface (blue green colored side) and printing surface carefully so they do not have fingerprints, dirt, dust, water, or scratches. Dust and dirt on the recording surface should be wiped gently with soft dry cloth, commercially available CD cleaner, or ethyl alcohol. Do not use benzine, thinner, or antistatic material.

CD/DVD:

Label side	Printable *Glossy labels other than the specified disc are not supported.
-------------------	--

Notes for handling the disc

Notes when using the disc

- Do not touch recording surface when holding it.
- Handle with care so that label surface and recording surface do not have fingerprints, dirt, dust, water drops, or scratches.
- Do not drop or shock discs.
- Do not apply excess force, like pinching with a clip, or bend.
- Do not attach an adhesive sticker to the disc. This may result in the disc being unable to record or play.

- ❑ Do not use in a place where lots of dirt and dust are present.
- ❑ Leaving disc stacked may result in discs to stick to each other.
- ❑ Touching or splashing water drops on printing surface right after printing may result in blurring.
- ❑ Let the discs dry naturally after printing. Touching the surface with your hand or splashing the surface with water right after printing may result in blurriness and stickiness.
- ❑ Printing is possible only on printing surface. When printing, use soft tipped writing equipment like a felt pen and do not use a ball point pen. Also, do not erase once printed.
- ❑ The recording surface side has a concentric ring projection called the stack ring. Depending on the disc, projection of the stack ring is small and use of such disc may cause the disc to stick before or after printing. It is recommended to check the disc before use.
- ❑ The specified discs have a moisture-adhesive ink receptor layer on the label surface. If stored stacked, especially under high humidity and high temperature conditions, disc may adhere to each other. If an automatic duplication machine is used, please check the disc before using.

Notes when storing the disc

- ❑ Do not store under direct sunlight, near heating equipment, or high humidity and temperature.
- ❑ Do not place where large temperature variance take place as condensation may occur.
- ❑ Do not place object on top of it.
- ❑ When storing, keep the disc in its disc case and avoid letting film or cards touch the printing surface. These may scratch the printing surface.
- ❑ Do not store discs in soft cases or bags which may touch the printing surface directly. This may cause discs to stick, color shading, or discoloration.
- ❑ Avoid storing with part of the printing surface covered, as this may cause smearing or dis-coloration.
- ❑ Avoid storing under high temperatures and high humidity, which may result in blurriness and stickiness of the printing surface.

Printable area

Printable area is the area for the label printing.

The printable area can be set from Set Inner/Outer Diameter screen of the EPSON Total Disc Maker.

In the Set Inner/Outer Diameter screen, you can select Standard, Wide, or set manually. Following diagram shows the printable area for Standard and Wide. Printing will be done in the gray area.

CD/DVD:

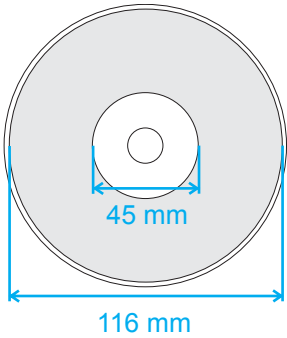
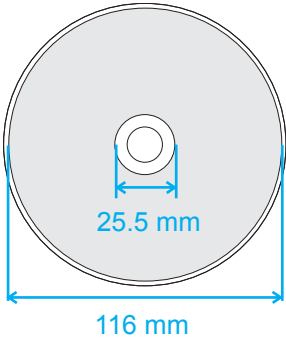
12-cm (4.72") CD/DVD (Standard)		12-cm (4.72") CD/DVD (Wide)	
			
Inner diameter	Outer diameter	Inner diameter	Outer diameter
45 mm (1.77")	116 mm (4.57")	25.5 mm (1.00")	116 mm (4.57")



Caution:

- ❑ *Make sure to set the inner diameter and the outer diameter within the areas shown above. Printing on sections outside the printable area may damage your CD/DVD drive.*
- ❑ *The EPSON Total Disc Maker can set between inner diameter of 18 mm to outer diameter of 119.4 mm (0.71 to 4.70"). However, printing outside printable area (45 to 116 mm) may result in sticking, staining of disc tray, peeling of print, and blurring of print. It is recommended to check the disc type before using.*
- ❑ *When printing outside printable area (ink absorbing layer) of the disc is being used, ink printed outside the printable area does not fix. Check the label of the printable area of the disc being used before setting.*
- ❑ *Precautions for setting the printable area*
 - Make sure that the printable area set does not exceed the printable area of the actual disc being used.*
 - Check whether coloration of print made on the rib (stack ring) is not uniform.*
 - Printing on the rib (stack ring) may cause ink sticking, disc sticking, and ink erasure after printing.*

- ❑ *Measures to be taken when printing outside printable area*
When printing inside the inner diameter results in ink sticking, disc sticking, and ink erasure, the following action can be taken to avoid that.
-Set Drying Time on the printer driver's printer settings screen and print. Although throughput may be reduced, problems will be avoided or reduced since the disc will be ejected after a set time.
-Enable Publish after Mask Rib Area. If you print from another application, set from the user-defined label setting in the printer driver. If you print from the Total Disc Maker, set from Set Inner/Outer Diameter setting.

Note:

When you print on CDs/DVDs with a commercially available software package that supports CD/DVD printing, you have to make the following settings.

Size	124 x 124 mm (4.88 x 4.88")
Type	CD/DVD Label, CD/DVD Premium Label, or Epson Specified CD/DVD Label
Margins on all sides	2 mm (0.08")

Ink cartridges

Color	Black, Yellow, Magenta, Light Magenta, Cyan, Light Cyan
Cartridge life	Use within 6 months of opening the package.
Temperature	Storage: -20 to 40 °C (-4 to 104 °F) 1 month at 40 °C (104 °F)



Caution:

- ❑ *Epson recommends the use of genuine Epson ink cartridges. Other products not manufactured by Epson may cause damage that is not covered by Epson's warranties, and under certain circumstances, may cause erratic behavior.*
- ❑ *Use the ink cartridge before the expiration date printed on its package.*
- ❑ *Do not refill the ink cartridge. Other products not manufactured by Epson may cause damage that is not covered by Epson's warranties, and under certain circumstances, may cause erratic behavior.*

Note:

- ❑ *The ink cartridges packaged with your product are partly used during initial setup. In order to produce high-quality printouts, the print head in your product will be fully charged with ink. This one-off process consumes a quantity of ink, and therefore these cartridges print fewer pages compared to subsequent ink cartridges.*
- ❑ *Do not store ink cartridges under high or freezing temperatures, or under direct sunlight.*

- ❑ To ensure that you receive premium print quality and to help protect your print head, a variable ink safety reserve remains in the cartridge when your product indicates to replace the cartridge. The yields quoted for you do not include this reserve.
- ❑ Cartridge yields vary considerably based on images printed, print settings, disc type, frequency of use and temperature. For print quality, a variable amount of ink remains in the cartridge after the ink lamp comes on. This product ships with full cartridges and part of the ink from the first cartridges is used for priming its printer. See www.discproducer.epson.com for more information about cartridges.
- ❑ Even when Black is selected for Print Mode Setting, all the ink colors are used in an operation designed to maintain the printing and print head quality.

Job processing

Job processing speed (during bidirectional printing)	Print Mode Setting (Quality/Speed)	(1): 50 discs/hr (2): 75 discs/hr (3): 95 discs/hr
Printing direction	bidirectional, unidirectional	

Note:

Above figures are based on Windows Vista. Job processing speed differs depending on the environment.

Number of products that can be connected to one computer

Number of products that can be connected to one computer	6
---	---

Printing

Printing method	On demand inkjet		
Head	Number of nozzles	180 per color	
Resolution	Print Mode Setting (Quality/Speed)	(1): 1,440 x 1,440 dpi (2): 1,440 x 720 dpi (3): 720 x 720 dpi	

dpi: number of dots every 25.4 mm (dots per inch)

Mechanical

Stacker capacity	Stacker 1 to 3: Max. about 50 discs Stacker 4: Max. about 5 discs
Dimensions	Width: 377 mm (14.8 inches) Depth: 465 mm (18.3 inches) Height: 348 mm (13.7 inches)
Weight	Approx. 22 kg (48.5 lb) with accessories

Electrical

Input voltage range	AC 100 to 240 V	
Rated frequency range	50 to 60 Hz	
Rated current	1.0 A	
Power consumption	Printing	41 W
	Standby mode	24 W

Note:

Check the label on the back of the product for its voltage.

Environmental

Temperature	Operation: 10 to 35 °C (50 to 95 °F) Storage: -20 to 40 °C (-4 to 104 °F) 1 month at 40 °C (104 °F)
Humidity	Operation:* ¹ 20 to 80% RH Storage:* ¹ 5 to 85% RH

*1 Without condensation

Standards and approvals

Safety	UL60950-1 CAN/CSA-C22.2 No.60950-1
EMC	FCC Part 15 Subpart B Class B CAN/CSA-CEI/IEC CISPR 22 Class B AS/NZS CISPR22 Class B
Low voltage directive 2006/95/EC	EN60950-1
EMC directive 2004/108/EC	EN55022 Class B EN61000-3-2 EN61000-3-3 EN55024
GOST-R	IEC60950-1 CISPR Pub. 22

Interface

High-Speed USB

Lifetime

Lifetime	5 years after the purchase or until 100,000 discs* ¹ have been published, whichever is shorter
-----------------	---

*1 With bidirectional printing

Note:

When the product has published 100,000 discs, it stops operating.

Epson estimates lifetime for the component of this product to be as follows:

Expected Lifetime:

Maintenance box life: About 30,000 discs printed

The maintenance box is estimated to need replacing after about 30,000 discs. Based on printing 3,000 discs per month, bi-directional. Actual results will vary based on such factors as images printed, print settings, media type, frequency of use and temperature.